

## **GPSMAP® 3006C/3010C** *color chartplotter*



© 2004–2007 Garmin Ltd. or its subsidiaries

Garmin International, Inc.  
1200 East 151<sup>st</sup> Street,  
Olathe, Kansas 66062, USA  
Tel. (913) 397.8200 or (800) 800.1020  
Fax (913) 397.8282

Garmin (Europe) Ltd.  
Liberty House  
Hounslow Business Park,  
Southampton, Hampshire, SO40 9RB UK  
Tel. +44 (0) 870.8501241 (outside the UK)  
0808 2380000 (within the UK)  
Fax +44 (0) 870.8501251

Garmin Corporation  
No. 68, Jangshu 2<sup>nd</sup> Road,  
Shijr, Taipei County, Taiwan  
Tel. 886/2.2642.9199  
Fax 886/2.2642.9099

All rights reserved. Except as expressly provided herein, no part of this manual may be reproduced, copied, transmitted, disseminated, downloaded or stored in any storage medium, for any purpose without the express prior written consent of Garmin. Garmin hereby grants permission to download a single copy of this manual onto a hard drive or other electronic storage medium to be viewed and to print one copy of this manual or of any revision hereto, provided that such electronic or printed copy of this manual must contain the complete text of this copyright notice and provided further that any unauthorized commercial distribution of this manual or any revision hereto is strictly prohibited.

Information in this document is subject to change without notice. Garmin reserves the right to change or improve its products and to make changes in the content without obligation to notify any person or organization of such changes or improvements. Visit the Garmin Web site ([www.garmin.com](http://www.garmin.com)) for current updates and supplemental information concerning the use and operation of this and other Garmin products.

Garmin® is a trademark of Garmin Ltd. or its subsidiaries, registered in the USA and other countries. GPSMAP®, AutoLocate®, TracBack®, BlueChart®, BlueChart® g2™, MapSource®, See-Thru®, DynaColor™, and Ultrascroll™ are trademarks of Garmin Ltd. or its subsidiaries. These trademarks may not be used without the express permission of Garmin.



## INTRODUCTION

Thank you for choosing the Garmin® GPSMAP® 3006C/3010C. The GPSMAP 3006C/3010C uses the proven performance of Garmin GPS and full-featured mapping to create an unsurpassed marine Multi-Function Display (MFD). Take a moment now to compare the contents of this package with the packing list on the outside of the box. If any pieces are missing, contact your Garmin dealer immediately.

### Installing Your GPSMAP 3006C/3010C

To install the GPSMAP 3006C/3010C, refer to the *GPSMAP 3006C/3010C & GPS 17 Installation Instructions*. To complete the installation, you need the appropriate fasteners, tools, and mounts listed in each section. Installation items not provided by Garmin should be available at most marine dealers. If you experience difficulty installing the unit, contact Garmin Product Support or an installation professional in your area.

### About This Manual

To get the most out of your new navigation system, read this manual and learn the operating procedures for your unit in detail. This manual is organized into the following sections:

The **Introduction** contains the Table of Contents, Product Registration, and the Software License Agreement.

The **Getting Started** section provides a unit overview and information that provides basic working knowledge needed to use the GPSMAP 3006C/3010C.

The **Basic Operation** section provides you with details and step-by-step instructions such as creating and using waypoints, navigating a route, and using the **FIND** key.

The **Main Pages** section provides detailed explanations about each page in the GPSMAP 3006C/3010C and step-by-step directions on using the pages.

The **Main Menu** section provides detailed explanations about the Main Menu and how to use it to configure your unit.

The **Using Sonar** section provides instructions on using a Garmin GSD 20, GSD 21 (Serial), or a GSD 22 (Ethernet) sounder with your GPSMAP 3006/3010.

The **XM WX Weather** section provides instructions on using a GDL 30/GDL 30A Marine Weather Satellite Receiver with your GPSMAP 3006/3010.

The **Radar** section provides instructions on using a GMR 20/40, GMR 21/41 or GMR 404/406 radar with your GPSMAP 3006/3010.

The **Appendix** contains specifications, regulatory information, unit care information, optional accessories, and maintenance information. You can also find warranty and FCC information in the Appendix.

An **Index** is provided at the end of the manual for reference.

## TABLE OF CONTENTS

<b>Introduction</b> .....	<b>i</b>	<b>Creating and Using Waypoints</b> .....	<b>14</b>
<b>Installing Your GPSMAP 3006C/3010C</b> .....	<b>i</b>	Creating Waypoints Using the ENTER/MARK Key .....	14
<b>About This Manual</b> .....	<b>i</b>	Creating Waypoints Using the Map .....	14
<b>Product Registration</b> .....	<b>v</b>	Creating Waypoints Manually .....	15
Contact Garmin.....	v	<b>Reviewing and Editing Waypoints</b> .....	<b>16</b>
<b>Software License Agreement</b> .....	<b>v</b>	Moving a Waypoint .....	18
<b>Warnings</b> .....	<b>vi</b>	Using Waypoint Lists.....	18
<b>Important Information</b> .....	<b>vi</b>	User Waypoints.....	19
<b>Getting Started</b> .....	<b>1</b>	Proximity Waypoints .....	20
<b>Unit Overview</b> .....	<b>1</b>	<b>Navigating to a Destination</b> .....	<b>21</b>
<b>Using the GPSMAP 3006C/3010C Keypad</b> .....	<b>2</b>	Selecting a Map Item Go To Destination.....	21
Using the Optional Marine Remote Control.....	3	Follow Track and TracBack Navigation .....	22
Using Soft Keys.....	4	TracBack Tips.....	24
Using Data Entry/Shortcut Keys .....	4	<b>Man OverBoard (MOB)</b> .....	<b>25</b>
Status Bar.....	4	<b>Creating and Using Routes</b> .....	<b>25</b>
<b>Turning on the GPSMAP 3006C/3010C</b> .....	<b>5</b>	Creating a New Route.....	25
Adjusting the Backlight .....	5	Navigating a Saved Route .....	26
<b>Initializing the GPS Receiver</b> .....	<b>6</b>	Creating a Quick NAV Route .....	27
Receiver Status and Accuracy .....	7	Copying a Route .....	27
GPS Setup.....	7	Deleting a Route .....	28
<b>Using Simulator Mode</b> .....	<b>8</b>	Editing a Route .....	28
<b>Basic Operation</b> .....	<b>9</b>	Planning Routes.....	31
<b>Using the GPSMAP 3006C/3010C</b> .....	<b>9</b>	<b>Main Pages</b> .....	<b>32</b>
Understanding the Features .....	9	<b>Configuring Main Pages</b> .....	<b>33</b>
Selecting Options and Entering Data.....	10	<b>Using Function Windows</b> .....	<b>35</b>
Using Additional Map Data.....	11	Function Window Adjustments .....	35
Using the Map Pointer .....	11	Viewing a Main Page in Full-Screen Mode.....	36
<b>Finding an Item</b> .....	<b>13</b>	<b>Map Page</b> .....	<b>36</b>
		Selecting Map Ranges .....	37
		Cartography .....	38
		Map Page Options .....	39

<b>Map Split Page</b> .....	<b>41</b>	<b>Alarms Tab</b> .....	<b>58</b>
<b>Compass Page</b> .....	<b>41</b>	System Alarms .....	59
<b>3D Highway Page</b> .....	<b>42</b>	Nav (Navigation) Alarms .....	59
Changing the Highway Perspective Range .....	43	Sonar Alarms .....	60
3D Highway Page Options .....	43	Weather Alarms .....	60
Showing or Hiding Maps .....	43	<b>System Tab</b> .....	<b>61</b>
<b>Video Page</b> .....	<b>44</b>	Update Sub Tab .....	66
Video Page Options .....	44	<b>Network Tab</b> .....	<b>66</b>
<b>Main Menu</b> .....	<b>45</b>	<b>Pages Tab</b> .....	<b>67</b>
<b>GPS Tab</b> .....	<b>45</b>	<b>Map Tab</b> .....	<b>68</b>
<b>Tide Tab</b> .....	<b>46</b>	AIS Sub Tab .....	71
Tide Sub Tab .....	46	<b>Radar Tab</b> .....	<b>72</b>
Current Sub Tab .....	48	<b>Temp (Temperature) Tab</b> .....	<b>73</b>
<b>Celestial Tab</b> .....	<b>49</b>	<b>Sonar Tab</b> .....	<b>73</b>
<b>Trip Tab</b> .....	<b>50</b>	<b>Highway Tab</b> .....	<b>74</b>
<b>Weather Tab</b> .....	<b>51</b>	<b>XM Tab</b> .....	<b>74</b>
<b>Points Tab</b> .....	<b>51</b>	Using Favorites .....	75
<b>Routes Tab</b> .....	<b>52</b>	<b>Using Sonar</b> .....	<b>76</b>
<b>Tracks Tab</b> .....	<b>53</b>	<b>Understanding Sonar</b> .....	<b>76</b>
<b>DSC (Digital Selective Calling) Tab</b> .....	<b>54</b>	Using Dual Frequency .....	76
Understanding DSC Distress Calls .....	55	Using Dual Beam .....	76
Understanding Position Reports .....	55	Understanding the Sonar Display .....	77
Review DSC Waypoint .....	55	<b>Sonar Page</b> .....	<b>78</b>
Setting Up DSC .....	56	Configuring the Sonar Page .....	79
Using the NAV Key .....	56	Using the Sonar Adjustment Menu .....	80
<b>Card Tab</b> .....	<b>57</b>	Using the Pointer on the Sonar Page .....	82
<b>Messages Tab</b> .....	<b>58</b>	Marking an Underwater Waypoint .....	82
Viewing Detailed Message Information .....	58	<b>Sonar Tab</b> .....	<b>82</b>
		General Sub Tab .....	83
		Graph Sub Tab .....	84
		Water Temp Sub Tab .....	85

<b>XM WX Weather</b> .....	<b>86</b>	<b>Appendix</b> .....	<b>101</b>
<b>Customizing Preset Weather Displays</b> .....	<b>86</b>	<b>Specifications</b> .....	<b>101</b>
<b>Weather Tab</b> .....	<b>88</b>	<b>Installing and Removing Data Cards</b> .....	<b>102</b>
Marine Bulletins Sub Tab .....	88	<b>Satellite Information</b> .....	<b>103</b>
<b>Using Radar</b> .....	<b>89</b>	<b>What is WAAS/EGNOS?</b> .....	<b>103</b>
<b>Understanding Radar</b> .....	<b>89</b>	<b>WAAS Capability</b> .....	<b>104</b>
Understanding the Radar Display .....	90	<b>Digital Selective Calling (DSC)</b> .....	<b>104</b>
<b>Radar Page</b> .....	<b>91</b>	What is DSC? .....	104
Configuring the Radar Page .....	91	<b>LORAN TD System</b> .....	<b>106</b>
Using the Radar Adjustment Menu .....	92	<b>Caring for the GPSMAP 3006C/3010C</b> .....	<b>107</b>
<b>Map Page Radar Overlay</b> .....	<b>97</b>	<b>Navigation Terms</b> .....	<b>108</b>
<b>Radar Tab</b> .....	<b>97</b>	<b>Messages and Alarms</b> .....	<b>110</b>
General Sub Tab .....	98	<b>Optional Accessories</b> .....	<b>112</b>
Display Sub Tab .....	98	<b>Limited Warranty</b> .....	<b>113</b>
MARPA Sub Tab .....	99	<b>FCC Compliance</b> .....	<b>114</b>
Advanced Sub Tab .....	100	Industry Canada Compliance .....	114
		<b>Declaration of Conformity (DoC)</b> .....	<b>114</b>
		<b>XM Satellite Radio Service Agreement</b> .....	<b>114</b>
		<b>Weather Data Warranty</b> .....	<b>115</b>
		<b>European License Requirements</b> .....	<b>116</b>
		<b>Index</b> .....	<b>117</b>

## Product Registration

Help us better support you by completing our online registration today! Connect to our Web site at [my.garmin.com](http://my.garmin.com). Keep the original sales receipt, or a photocopy, in a safe place.

### Contact Garmin

Contact Garmin if you have any questions while using your GPSMAP 3006C/3010C. In the USA contact Garmin Product Support by phone: (913) 397-8200 or (800) 800-1020, Monday–Friday, 8 AM–5 PM Central Time; or go to [www.garmin.com/support/](http://www.garmin.com/support/).

In Europe, contact Garmin (Europe) Ltd. at +44 (0) 870.8501241 (outside the UK) or 0808 2380000 (within the UK).

## Software License Agreement

BY USING THE GPSMAP 3006C/3010C, YOU AGREE TO BE BOUND BY THE TERMS AND CONDITIONS OF THE FOLLOWING SOFTWARE LICENSE AGREEMENT. PLEASE READ THIS AGREEMENT CAREFULLY.

Garmin grants you a limited license to use the software embedded in this device (the “Software”) in binary executable form in the normal operation of the product. Title, ownership rights, and intellectual property rights in and to the Software remain in Garmin.

You acknowledge that the Software is the property of Garmin and is protected under the United States of America copyright laws and international copyright treaties. You further acknowledge that the structure, organization, and code of the Software are valuable trade secrets of Garmin and that the Software in source code form remains a valuable trade secret of Garmin. You agree not to decompile, disassemble, modify, reverse assemble, reverse engineer, or reduce to human readable form the Software or any part thereof or create any derivative works based on the Software. You agree not to export or re-export the Software to any country in violation of the export control laws of the United States of America.

## Warnings

**Failure to avoid the following potentially hazardous situations could result in an accident or collision resulting in death or serious injury.**

- When navigating, carefully compare information displayed on the unit to all available navigation sources, including information from visual sightings, and maps. For safety, always resolve any discrepancies or questions before continuing navigation.
- Use the electronic chart in the unit only to facilitate, not to replace, the use of authorized government charts. Official government charts and notices to mariners contain all information needed to navigate safely.
- Use this unit only as a navigational aid. Do not attempt to use the unit for any purpose requiring precise measurement of direction, distance, location, or topography.

**WARNING:** This product, its packaging, and its components contain chemicals known to the State of California to cause cancer, birth defects, or reproductive harm. This Notice is provided in accordance with California's Proposition 65. See [www.garmin.com/prop65](http://www.garmin.com/prop65) for more information.

The **California Electronic Waste Recycling Act of 2003** requires the recycling of certain electronics. For more information on the applicability to this product, see [www.ecycle.org](http://www.ecycle.org).

 - LAMPS INSIDE THIS PRODUCT CONTAIN MERCURY AND MUST BE RECYCLED OR DISPOSED OF ACCORDING TO LOCAL, STATE, OR FEDERAL LAWS.

For more information go to:

[www.garmin.com/aboutGarmin/environment/disposal.jsp](http://www.garmin.com/aboutGarmin/environment/disposal.jsp)

## Important Information

**MAP DATA INFORMATION:** One of the goals of Garmin is to provide customers with the most complete and accurate cartography that is available to us at a reasonable cost. We use a combination of governmental and private data sources, which we identify in product literature and copyright messages displayed to the consumer. Virtually all data sources contain some inaccurate or incomplete data. In some countries, complete and accurate map information is either not available or is prohibitively expensive.



# GETTING STARTED

## Unit Overview

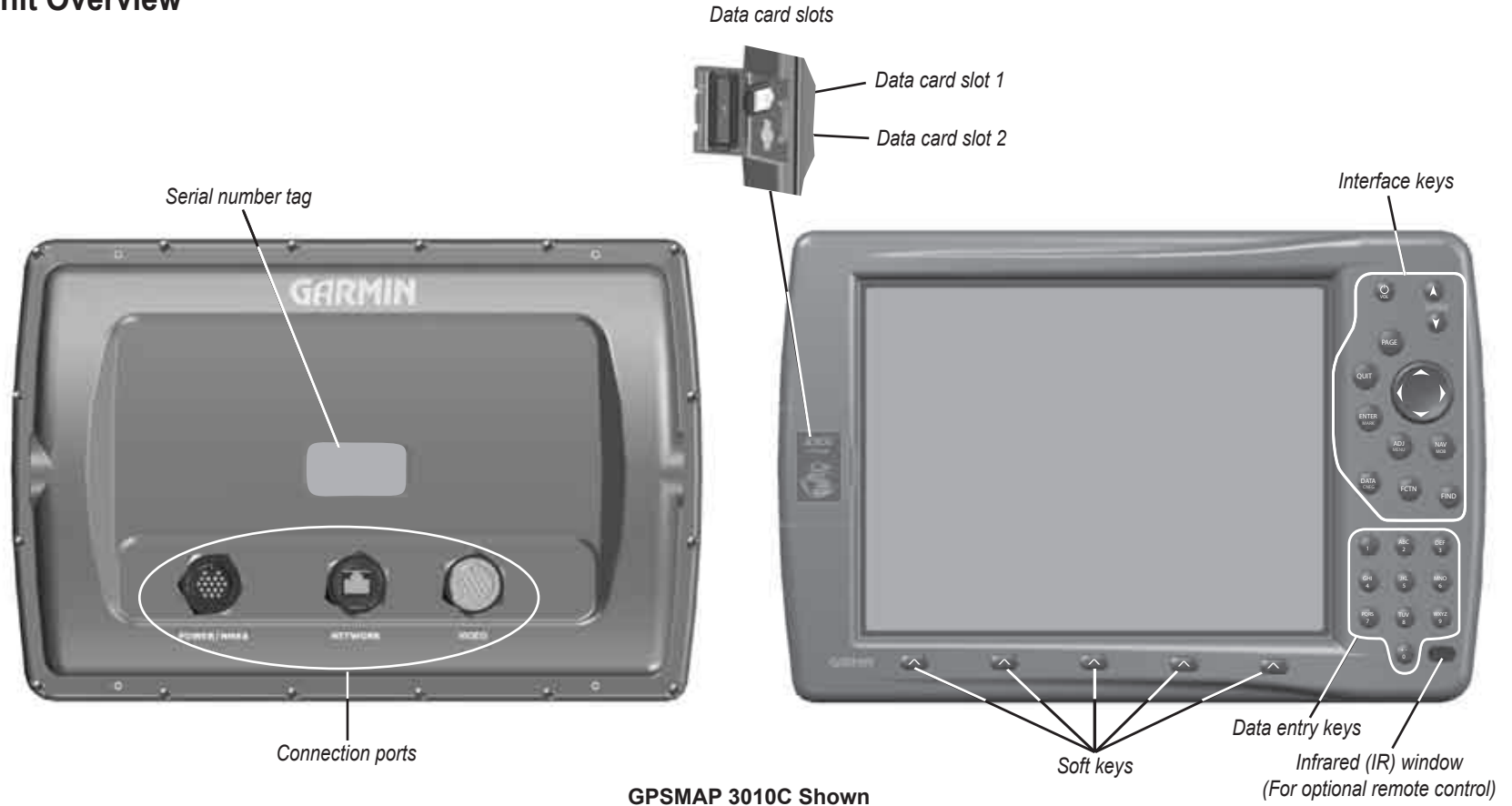

**GPSMAP 3010C Shown**

## Using the GPSMAP 3006C/3010C Keypad

### POWER/BACKLIGHT Key

- Press and hold to turn the unit on or off.
- Press and release to adjust backlighting.

### PAGE Key

- Press to cycle through the main pages in sequence.
- Press to end an operation in progress and return to the main page.

### QUIT Key

- Press to cancel data entry or exit a page.

### ENTER/MARK Key

- Press and release to enter highlighted items and data or confirm on-screen messages.
- Press and hold to mark your current location as a waypoint.

### DATA/CNFG Key

- Press to show or hide function windows and data fields on a main page.
- Press and hold to open the Configuration window.



### RANGE Keys

- Press to zoom in or out on the map.
- Press to adjust the range of the sonar and radar

### ROCKER Key

- Press up, down, right, or left to move through lists, highlight fields, enter data, or move the map pointer.

### ADJ/MENU Key

- Press and release to view options for a page.
- Press and hold to open the Main Menu.

### NAV/MOB Key

- Press to open the Navigation Menu.
- Press and hold to mark a MOB waypoint and create a track back to the marked location.

### FCTN Key

- Press to cycle through function windows.

### FIND Key

- Press to search for points, such as user waypoints, cities, and services.

### Using the Optional Marine Remote Control

Use the keypad on the optional Marine Remote Control to operate your GPSPMAP 3006C/3010C from a distance. Contact your Garmin dealer or Garmin Product Support to purchase the Marine Remote Control.

To operate the remote control, point the IR (infrared) window on the remote toward the unobstructed IR window on the lower-right corner of the GPSPMAP 3006C/3010C.

All keys on the remote control operate in the same manner as the keypad on the GPSPMAP 3006C/3010C. Each key's primary function appears on the key. To activate the secondary functions for the **ADJ/MENU**, **NAV/MOB**, **DATA/CNFG**, and Thumb Stick (**ENTER/MARK**) keys, press and hold the key.

The Thumb Stick combines the operations of the **ROCKER** and **ENTER/MARK** key. Use it to select menu options, change settings, enter data, and confirm entry. You can also control movement of the pointer on the Map Page. Press in on the Thumb Stick to select a highlighted item or begin data entry. Press and hold the Thumb Stick to mark a waypoint.

### Installing the Remote Control Batteries

The remote requires two AAA alkaline batteries. To install the batteries, press down on the battery door clip, and then pull the battery door away from the remote. Install the batteries, observing the correct polarity (see the inside of the battery compartment). Replace the cover, and make sure it is closed all the way.



**NOTE:** The remote is for use in shaded or enclosed environments. Direct sunlight interferes with infrared operation. The Marine Remote Control is NOT waterproof.



Marine Remote Control

## Using Soft Keys

Soft keys are located along the bottom of the display and are used as shortcuts to select the most commonly used options for the selected page, window, or tab. To select a soft key, press the  key directly below it.

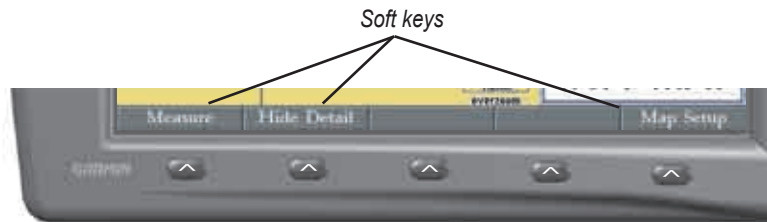

## Using Data Entry/Shortcut Keys



Use the data entry keys to enter alphanumeric data into the unit, such as a waypoint name. Use data entry keys in conjunction with the **ROCKER**. Press the key once to select the first letter on the key, twice to select the second letter on the key, three times to select the third letter on the key, or four times to select the number on the key. When you have selected the correct letter or number, pause, and the unit advances the cursor to the next character automatically.

Use the shortcut keys to jump to main pages, or select menu and list options by pressing the corresponding number of the selection. For numbers 1-9, press the number to choose the selection. For numbers 10 and higher, press the first digit, then press the second digit within one second.

## Status Bar

At the top of each page, the status bar provides current status information for connected devices and several of the chartplotter functions. As additional devices are added to the GPSMAP 3006/3010 or the Garmin Marine Network, an icon for each device appears on the status bar.

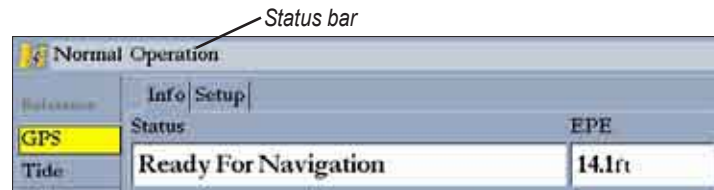

Alarm alerts also appear on the status bar. To acknowledge an alarm, press **QUIT**. If an alarm condition persists, it appears on the status bar until the alarm condition no longer exists. For more information about alarms, see [pages 58-60](#).



## Turning on the GPSMAP 3006C/3010C

Before you turn on the GPSMAP 3006C/3010C, make sure the unit and GPS 17 antenna are correctly installed on your vessel according to the instructions in the *GPSMAP 3006C/3010C & GPS 17 Installation Instructions*.

The first time you turn on the GPSMAP 3006C/3010C, the GPS 17 receiver must collect satellite data and determine its current location. To ensure proper initialization, the GPSMAP 3006C/3010C is shipped from the factory in AutoLocate mode.

### To turn on the GPSMAP 3006C/3010C:

1. Press and hold the **POWER** key until the unit turns on.
2. When **I Agree** is highlighted on the Warning Page, press **ENTER** to open the Map Page.

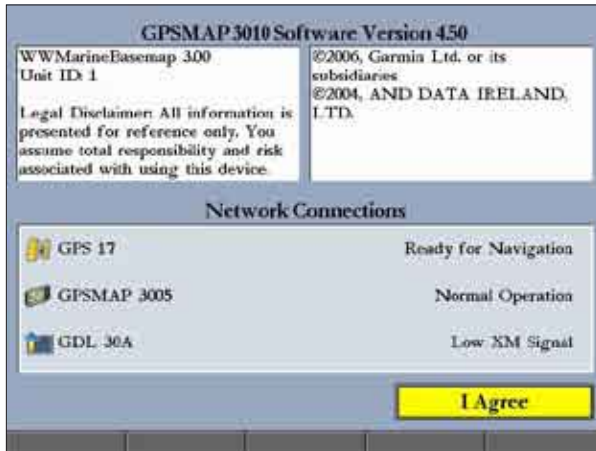

### To turn off the GPSMAP 3006C/3010C:

Press and hold the **POWER** key until the unit turns off.

## Adjusting the Backlight

You can adjust the screen backlighting on the GPSMAP 3006C/3010C from any page by using the **POWER/BACKLIGHT** key.

### To adjust the backlight level:

1. Press and release the **POWER/BACKLIGHT** key.
2. Press up on the **ROCKER** to increase the brightness, or press down to decrease.



**TIP:** After you open the Backlight adjustment window, press the **POWER/BACKLIGHT** key repeatedly to cycle through the three backlight settings: Highest, Middle, and Lowest.

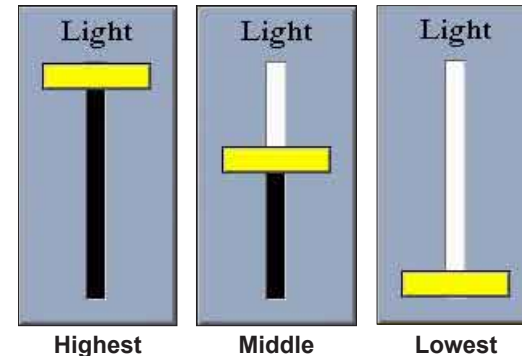

3. Press **ENTER** or **QUIT** to close the Backlight adjustment window.

## Initializing the GPS Receiver

When you turn on the GPSMAP 3006C/3010C, a Warning Page appears, showing unit information, network connections (attached devices), and important information regarding the proper use of the unit. It takes a few seconds for the GPSMAP 3006C/3010C to search for attached devices. When the search is complete, the **I Agree** button is highlighted. After reading the warning, press **ENTER**.

Next, you see the first of the main pages, the Map Page. The GPSMAP 3006C/3010C begins searching for GPS satellites. The first time the unit acquires satellites takes several minutes. Afterward, acquisition times are quicker during normal use. The GPS status icon on the left side of the status bar shows the progress of the satellite acquisition process.

GPS status icon colors are:

- **Red**—acquiring satellites/lost satellite reception.
- **Orange**—ready for navigation/ready for navigation with WAAS.
- **Gray**—lost GPS connection. (Check GPS antenna wiring connections.)

A detailed visual reference of the satellite acquisition, GPS receiver status, and accuracy is available on the **GPS** tab on the Main Menu.

### To view the GPS tab information:

1. Press and hold **ADJ/MENU** to open the Main Menu.
2. Use the **ROCKER** to highlight the **GPS** tab.

When viewing the GPS Info sub tab, a signal strength bar for each satellite in view appears on the right of the page, with the appropriate satellite number underneath each bar. The numbers below each bar represent the particular satellite that is being received. Numbers above 33 indicate WAAS satellites. For more information about WAAS, see the “Appendix”.

The sky view shows a birds-eye view of the location of each satellite relative to the receiver’s last known location. The outer circle represents the horizon (north up), the inner circle 45° above the horizon, and the center point a location directly overhead. You can also set the sky view to track up, which causes the top of the sky view to align along your current track heading.

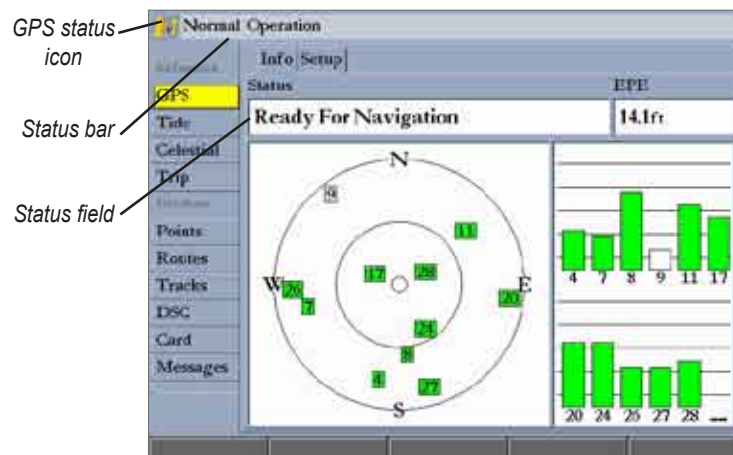

GPS Tab

The progress of satellite acquisition is shown in three stages:

- **No signal strength bars**—the receiver is looking for the satellites indicated.
- **Hollow signal strength bars**—the receiver has found the indicated satellite(s) and is collecting data.
- **Solid green signal strength bars**—the receiver has collected the necessary data and the satellite(s) are ready for use.

## Receiver Status and Accuracy

The receiver status is shown in the Status field on the Info sub tab. Current accuracy is shown in the EPE (Estimated Position Error) field. Accuracy uses the number of received GPS satellites, signal strength, and satellite orientation, to calculate location accuracy in feet or meters. The Status field shows one of the following conditions:

- **Searching for Satellites**—the receiver is looking for any satellites and collecting data from satellites visible at its last known or initialized location, but has not collected enough data to calculate a fix. This process can take up to five minutes.
- **Ready For Navigation**—at least three satellites with good geometry have been acquired, and your location is now being calculated in latitude and longitude; or at least four satellites have been acquired and your location is being calculated in latitude, longitude, and elevation. “Ready For Navigation with WAAS” appears when you are receiving WAAS satellite corrections in 2D or 3D, and a D appears on the strength bar of satellites being corrected.

After the receiver has collected information from at least three satellites, the Status field shows either “Ready for Navigation” or “Ready for Navigation with WAAS”. The GPSMAP 3006C/3010C is now ready for use. Press **QUIT** to return to the Map Page.

## GPS Setup

The Setup sub tab provides access to functions and features relating to initializing the GPS receiver.

### To access the GPS Setup sub tab:

1. Press and hold **ADJ/MENU** to open the Main Menu.
2. Highlight the **GPS** tab, and then highlight the **Setup** sub tab.



Setup Sub Tab

The Setup sub tab contains the following options:

- **Skyview Orientation**—allows you to select a sky view orientation, either **North Up** or **Track Up**, for the GPS Info sub tab only.
- **Source**—set to **Garmin** when using a Garmin sensor (GPS 17); set to **NMEA** when using any other GPS NMEA source.
- **WAAS**—turns WAAS on or off.

The following soft keys are active only when the unit is not receiving satellites and the Source is not set to **Garmin**:

- **AutoLocate**—allows the receiver to find your location automatically. This process can take up to five minutes.
- **Set Position**—allows you to initialize the receiver from the Map Page to initially help the receiver acquire satellites more quickly.

## Using Simulator Mode

Simulator Mode is great for practicing with the unit if you are indoors and satellite signals are not available. When the GPSMAP 3006C/3010C is in Simulator Mode, the GPS receiver is turned off. The unit cannot be used for actual navigation.



**NOTE:** Do not try to navigate in Simulator Mode. While in Simulator Mode, the GPS receiver is turned off. Any satellite signal strength indicators shown are only simulations and do not indicate the strength of actual satellite signals.

### To turn on Simulator Mode:

1. Press and hold **ADJ/MENU** to open the Main Menu.
2. Press up or down on the **ROCKER** to highlight the **System** tab.
3. Press right on the **ROCKER** to highlight the **General** sub tab.
4. Highlight the **System Mode** field, and press **ENTER**.
5. Highlight **Simulator**, and press **ENTER**.

When Simulator Mode is active, the message “Simulating Operation” appears in the status bar at the top of each page.

### To set up Simulator Mode:

Highlight the **Setup** button, and press **ENTER**. The Simulator Setup window appears. The following options are available:

- **Current Time/Date**—enter a simulated date and time.
- **Speed**—enter a simulated speed.
- **Track Control**—select track control. **Auto Track** steers to the current navigation point; **User Track** allows you to enter a heading in the **Track** field.
- **Track**—enter a simulated heading.



Use the **Set Position** soft key to set your location while in Simulator Mode.

You can also control the speed and track from the Compass or 3D Highway Pages. Press up or down on the **ROCKER** to increase or decrease the speed; press left or right to change the heading.

### To turn off Simulator Mode:

1. Press and hold **ADJ/MENU** to open the Main Menu.
2. Press up or down on the **ROCKER** to highlight the **System** tab.
3. Press right on the **ROCKER** to highlight the **General** sub tab.
4. Highlight the **System Mode** field, and press **ENTER**.
5. Highlight **Normal**, and press **ENTER**.

When Normal Mode is active, the message “Normal” appears in the status bar at the top of each page.



## BASIC OPERATION

### Using the GPSMAP 3006C/3010C

This section explains how to enter and select information with the GPSMAP 3006C/3010C.

#### Understanding the Features

The advanced keypad system on the GPSMAP 3006C/3010C is designed to allow you to select options and enter data quickly and conveniently. As you progress through this owner's manual, you are directed to press a specific key or highlight a field on the screen. When you are directed to press a key, you should press and quickly release the key. If you need to hold down the key for a period of time to activate a secondary function, the instructions tell you to do so. The location of the highlight is controlled by the **ROCKER**. When a field is selected on the screen, it is highlighted in yellow.

The following terms are used throughout this manual:

- **Highlight**—move the highlighted area on the screen up, down, left, or right with the **ROCKER** to select individual fields. Moving the highlight to a given location allows you to make a selection, begin data entry, or scroll through a list.
- **Field**—the location on a page where data or an option can be entered and displayed. Highlight a field using the **ROCKER** to begin entering data or selecting options.
- **Soft keys**—located along the bottom of the screen, soft keys are used as shortcuts to select the most commonly used options for the selected page, window, or tab. To select a soft key, press the  key directly below it.
- **On-Screen button**—use the **ROCKER** to highlight an on-screen button, and press **ENTER** to select the button.

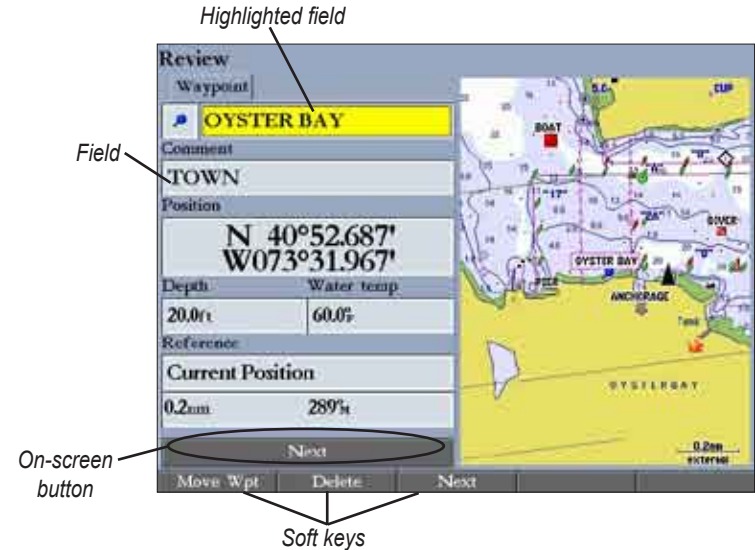

- **Scroll bar**—When viewing a list of items too long to show on the screen, a scroll bar appears along the right side of the list. To scroll through a list, press up or down on the **ROCKER**. Press right or left on the **ROCKER** to scroll one page at a time.
- **Default**—the factory settings saved in the unit's memory. You can change the settings, but you can also revert to the factory (default) settings when you press the **Factory Defaults** soft key on the System-General sub tab.

## Selecting Options and Entering Data

To select options and enter data, use the **ROCKER** to highlight or select an item in a list or a field on the screen. Use the **ENTER** key, soft keys, data entry keys, and the **ROCKER** to select options, enter names and numbers in data fields, and activate your selections.

### To select an optional feature:

1. From any page, press **ADJ**. The adjustment menu shows a list of optional features specific to that page.



2. Use the **ROCKER** to move the highlight up, down, left, or right to the selection you want, and press **ENTER** to select the option.

OR

Press the soft key below the option you want to select.

### To select an on-screen button:

On a page with on-screen buttons, use the **ROCKER** to highlight an on-screen button, and press **ENTER**.

### To select an option using soft keys:

Press the  button below the soft key you want to select.

### To select an option using data entry shortcut keys:

1. From any page, press **ADJ**. The adjustment menu for the current page or selected function appears.

2. Press the data entry key that corresponds to the option you want to select. For numbers 10 and higher, press the first digit, and then press the second digit within one second.



### To exit a menu or return to the previous setting:

Press **QUIT**. The **QUIT** key moves backward through your steps. Press **QUIT** repeatedly to return to the starting page.

### To enter data in a data field:

1. Use the **ROCKER** to highlight the data field, and press **ENTER**.
2. Press up or down on the **ROCKER** to select characters. Press and release the **ROCKER** to move character by character through the list; press and hold the **ROCKER** to move rapidly through the list.

- Press right on the **ROCKER** to move to the next character on the line or press left to move back to the previous character. Press left on the **ROCKER** from the first character position to clear the field. If there are more than two lines of data, keep pressing right on the **ROCKER** to go to the next line.
- Press **ENTER** to accept data and move to the next field.

Not all data fields are programmable. When moving around a page with these fields, the highlight skips them.

### Using Additional Map Data

The GPSMAP 3006C/3010C comes standard with a built-in basemap showing cities, interstates, coastline detail, and U.S. Tide stations. Optional preprogrammed Garmin data cards and MapSource CD-ROMs and DVDs enhance the versatility of your GPSMAP 3006C/3010C. With optional BlueChart cartography, you can access marine nav aids, wrecks, obstructions, anchorage locations, shaded depth contours, inter-tidal zones, spot soundings, port plans, and more.

The GPSMAP 3006C/3010C supports BlueChart® g2™ cartography. This cartography features integrated mapping, 2-D or 3-D map perspective, tide and current data, improved IALA symbols, nav aids, marinas, boat ramps, roads, and more. You can also access additional data including highly detailed coastal roads and points of interest such as restaurants, lodging, and local attractions. Full-color aerial photographs of ports, marinas, bridges, and navigational landmarks are also included on many preprogrammed BlueChart g2 data cards.

See your Garmin dealer or visit the Garmin Web site ([www.garmin.com](http://www.garmin.com)) for more information on preprogrammed Garmin data cards and other MapSource programs.



**NOTE:** When networking with a Garmin GPSMAP 4000 or 5000 series unit, map data is not shared.

### Using the Map Pointer

Use the map pointer to pan away from your current location and scroll to other map areas around the world (even outside of your current detail coverage). As you pan past the edge of the current map display, the screen actively scrolls forward to provide continuous map coverage. An hourglass symbol appears by the pointer while the unit is busy drawing new map detail.

Controlled by the **ROCKER**, the map pointer is an important tool that can be used to pan to other map locations, mark and edit waypoints and routes, and review location data of on-screen map items and waypoints.



#### To move the map pointer:

Press the **ROCKER** to move the map pointer up, down, left, right, or diagonally.

As you move the map pointer, the distance and bearing from your current location to the map pointer are shown in the upper-left corner of the map, with the map pointer's location coordinates. Keep in mind that when the map pointer is stationary, the distance and bearing from your present location changes as your boat moves. The map pointer can also be used to jump to an on-screen waypoints and map items, allowing you to review a selected location directly from the map.

### To select an on-screen waypoint or map item with the map pointer:

1. Use the **ROCKER** to move the pointer to the waypoint or map item. When a waypoint or map item is selected, it is highlighted on-screen with the name and location shown.
2. Press **ENTER** to view details of the map item. When using BlueChart or MapSource data, or if waypoints are grouped tightly together due to the Range setting, additional tabs appear on the Review Waypoint Page. Use the **ROCKER** to highlight the individual tabs to view the information and additional options.

### To eliminate the pointer and re-center your location on the map:

Press **QUIT**.

### To view additional BlueChart chart notes:

1. Select an on-screen BlueChart map item, and press **ENTER**.
2. Use the **ROCKER** to highlight the **Chart <name>** tab. A chart summary appears below the tab.
3. Highlight the **Notes** soft key, and press **ENTER**. Notes for the chart appear.



BlueChart Notes

4. Highlight the notes field, and press **ENTER**.
5. Use the **ROCKER** to scroll the text up or down.
6. Press **QUIT** to exit.

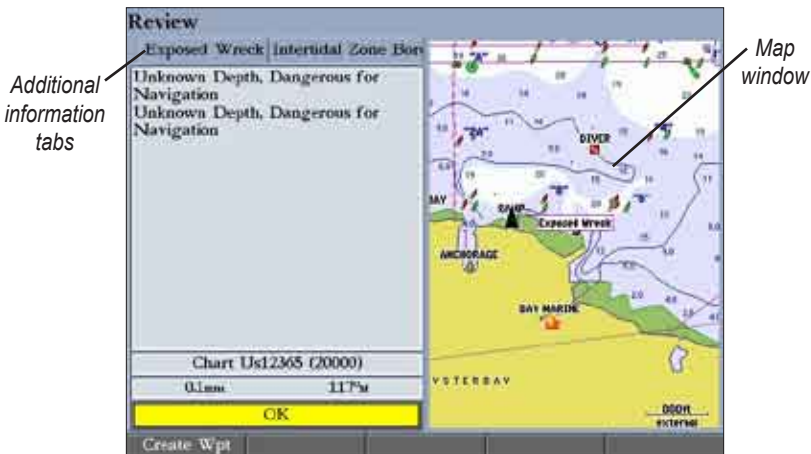

## Finding an Item

Press **FIND** to search for items including waypoints, anchorages, cities, marine services, nav aids, restricted areas, wrecks, celestial information, tides, and currents. If you pan the map window and press **FIND**, the unit centers its search from the map pointer location. When using BlueChart, BlueChart g2, or MapSource data, your location or the map pointer must be within the map outline area to search for information from that area.

### To find an item from your current location:

1. From any page, press **FIND** to open the Find From Current Position Page.

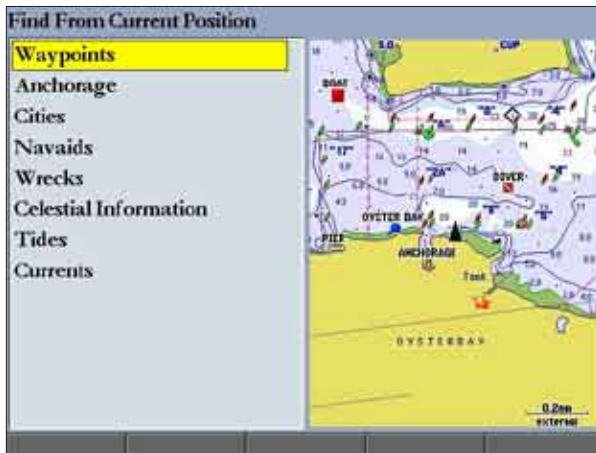

2. Highlight a category, and press **ENTER**. Select a subcategory, if necessary.
3. Some items have a **By Name** tab. For **By Name**, select the top field to spell out the name, or scroll through the list.

4. Some items have a **Filter List** button that allows you to enter letters or numbers of the item name. The search result shows only items matching the entered letters or numbers. Highlight the **Filter List** button, and press **ENTER**. Enter data, as needed, to narrow your search.

### To find an item from another location on the map:

1. Open the Map Page. Use the **ROCKER** to pan to the location you want, and then press **FIND**. The Find From (Location) Page appears.
2. Using the **ROCKER**, highlight a category, and press **ENTER**.

### To view details about an item:

Highlight an item in the search results list, and press **ENTER**. The Review Page appears, showing item information, map location, chart name, distance/bearing, and options for creating a waypoint or viewing the next item in the search results list.

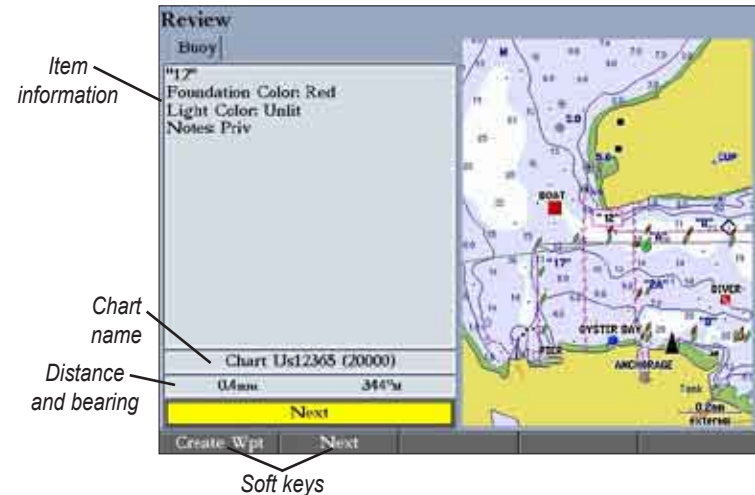

## Creating and Using Waypoints

The GPSMAP 3006C/3010C stores up to 4,000 alphanumeric waypoints, each with a user-defined icon, comment, depth, and water temperature.



**NOTE:** If you are using a Garmin GSD 20, GSD 21, or GSD 22 Sounder Module, the **Depth** and **Water Temp** fields fill in automatically.

You can create waypoints using three basic methods:

- **ENTER/MARK**—use the **ENTER/MARK** key to quickly mark your current location.
- **Graphically**—use the map display to define a new waypoint location.
- **Manually**—enter new waypoint coordinates manually.

### Creating Waypoints Using the ENTER/MARK Key

Use the **ENTER/MARK** key to capture your current location or pointer or map item location to create a new waypoint. You must have a valid position fix to mark your current location.

#### To mark your current location:

1. Press and hold **ENTER/MARK** until the Review Waypoint Page appears. The GPSMAP 3006C/3010C captures its current location and creates a default name and symbol for the new waypoint.
2. To accept the waypoint with the default name and symbol, press **ENTER**. To change any of the available waypoint information, see [page 16](#).



Review Waypoint Page (BlueChart Data Shown)

### Creating Waypoints Using the Map

You can create a waypoint by using the map pointer to point to any map location or map feature. When you move the pointer over a map item, you see a highlighted description of the item.

#### To create a new waypoint using a map location:

1. Use the **ROCKER** to move the pointer to the map location you want.
2. Press and quickly release **ENTER/MARK** to capture the pointer location. Do not hold the button down; doing so marks your current location, not the map location. The Review Waypoint Page appears.
3. To accept the waypoint with the default information, press **ENTER**.  
OR  
To change any waypoint information, highlight the appropriate field and press **ENTER**. After entering your changes, press the **OK** soft key.

**To create a new waypoint from a map feature:**

1. Use the **ROCKER** to move the map pointer and highlight the map feature you want.
2. Press **ENTER/MARK** to capture the pointer location. The Review Page for the selected map feature appears.
3. Press the **Create Wpt** soft key to open the Review Waypoint Page.
4. To accept the waypoint with the default information, press **ENTER**.

OR  
To change any waypoint information, highlight the appropriate field and press **ENTER**. After entering your changes, press the **OK** soft key.



Creating a Waypoint from a Map Feature  
(BlueChart Data shown)

**Creating Waypoints Manually**

You can manually enter position coordinates to create a waypoint using the Points tab on the Main Menu. This method is useful for creating a waypoint at a specific latitude/longitude position from a chart or other source.



**CAUTION:** When entering a waypoint manually, be sure that the unit is set to the same position format and map datum as the paper chart or coordinates source. Entering coordinates into the GPSMAP 3006C/3010C while it is set to a datum different from the datum in which the coordinates were created can result in an incorrect waypoint location.

Enter location coordinates manually.



Review Waypoint Page

**To create a new waypoint by entering position coordinates:**

1. Press and hold **ADJ/MENU** to open the Main Menu.
2. Highlight the **Points** tab. You can also mark your present location using the steps on [page 14](#), and then proceed to step 4.

3. Press the **New Waypoint** soft key. The Review Waypoint Page appears with the next available waypoint number and the receiver's last known location as the default name and location.
4. Use the **ROCKER** to highlight the **Position** field, and press **ENTER**.
5. Enter position coordinates using the **ROCKER** or data entry keys, and press **ENTER**.
6. To accept the waypoint with the default information, press the **OK** soft key OR  
To change any waypoint information, highlight the appropriate field and press **ENTER**. After entering your changes, press the **OK** soft key.

Two other options are available on the Review Waypoint Page:

- **Add to Route**—adds the new waypoint to the end of a route.
- **Move Wpt** (waypoint)—moves or projects the waypoint to a new location on the map.

#### To add a new waypoint to a route:

1. Press the **Add To Route** soft key. The Select Route Page appears.
2. Highlight a route or **New Route**, and press **ENTER**.
3. Press the **OK** soft key to add the waypoint to the route.

For more information about using routes, see “Creating and Using Routes,” beginning on [page 25](#).

## Reviewing and Editing Waypoints

After you create a waypoint, you can modify, review, rename, move, or delete it using the Review Waypoint Page. This page shows waypoint details, and a map window that you can pan or zoom in and out.

#### To access the Review Waypoint Page:

Use the **ROCKER** to highlight a waypoint on the Map Page, and press **ENTER**.

#### To access the Review Waypoint Page from a waypoint list:

1. Press and hold **ADJ/MENU** to open the Main Menu. Use the **ROCKER** to highlight the **Points** tab, and then highlight a waypoint from the list.
2. Press **ENTER** to open the Review Waypoint Page.



**NOTE:** Additional information tabs do not appear in this mode.



Review Waypoint Page



**To change the waypoint name:**

1. Highlight the waypoint name field, and press **ENTER**.
2. Use the **ROCKER** to enter a new name, and press **ENTER**.

**To change the waypoint symbol:**

1. Highlight the waypoint symbol field to the left of the waypoint name, and press **ENTER**.
2. Use the **ROCKER** to select a different symbol, and press **ENTER**.

**Waypoint Symbol List****To change the Comment, Position, Depth, or Water temp:**

1. Highlight the **Comment**, **Position**, **Depth**, or **Water temp** field, and press **ENTER**.
2. Use the **ROCKER** to enter new data, and press **ENTER**.

**To access the map window on the Review Waypoint Page:**

1. Press **FCTN** to highlight the map window. You can pan the map, change the map range, or use the map pointer to select a location.

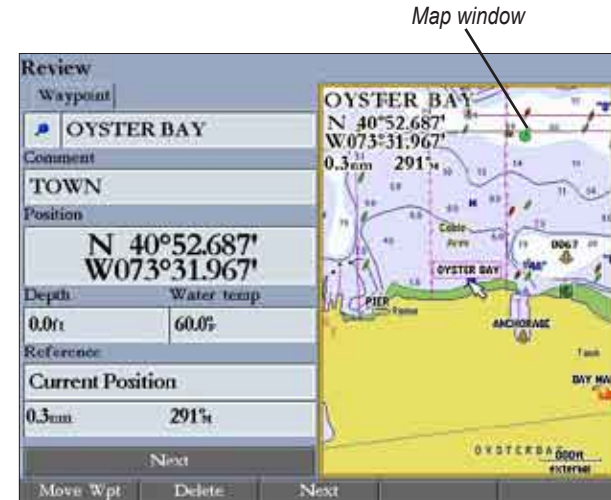
**Review Waypoint Page**

2. Press **FCTN** to return to the left side of the Review Waypoint Page.

## Moving a Waypoint

You can modify a waypoint by moving or “projecting” the distance and bearing from its present location to a new location.

### To move the waypoint on the map:

1. Press the **Move Wpt** soft key. The map window on the right side of the page is highlighted with the selected waypoint centered and highlighted on a map. The word **MOVE** appears below the pointer.
2. Use the **ROCKER** to move the waypoint to the new location. The distance and bearing from the waypoint’s current location appears in the upper-left corner of the map window.
3. Press **ENTER** to accept the new waypoint location.



4. Press **FCN** to return to the left side of the Review Waypoint Page.

## Using Waypoint Lists

The Points tab on the Main Menu has two sub tabs, User and Proximity, which allow you to manage a large number of waypoints quickly and efficiently. The Proximity sub tab also provides a continuously updated proximity waypoint alarm that you can use to define an alarm circle around submerged hazards or shallow waters.

### To access the Points tab from the Main Menu:

1. Press and hold **ADJ/MENU** to open the Main Menu.
2. Use the **ROCKER** to highlight the **Points** tab, and highlight either the **User** or **Proximity** sub tab.

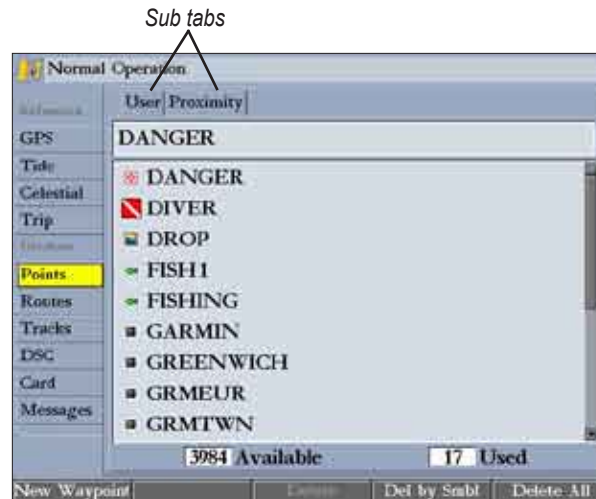

## User Waypoints

The User sub tab on the Points tab shows a master list of all waypoints currently stored in memory. From the User sub tab, you can review, edit, rename, or delete individual waypoints, or delete all user waypoints. The number of available and used waypoints is shown at the bottom of the User sub tab. Stored waypoints are arranged in alphanumeric order.

### To scroll through and review the waypoint list:

1. Use the **ROCKER** to highlight the **Points** tab on the Main Menu, and then highlight the **User** sub tab.
2. Press up or down on the **ROCKER** to scroll through the list of waypoints; press right or left on the **ROCKER** to scroll by page.
3. Press **ENTER** to review the highlighted waypoint on the Review Waypoint Page. See [page 16](#) for information on reviewing and editing waypoints.
4. Press the **Next** soft key to return to the waypoint list. The next waypoint in the list is automatically highlighted.

## Deleting Waypoints

The following soft keys are available when you highlight a waypoint on the User sub tab:

- **New Waypoint**—creates a new waypoint.
- **Delete**—deletes the selected waypoint from the list and from any route in which the waypoint was used.
- **Del by Smb1**—deletes waypoints that use the same symbol.
- **Delete All**—deletes all waypoints from the unit.



**NOTE:** When you delete a waypoint from the list, it cannot be recovered from the unit. Save important waypoints to a data card, or write them down.

### To delete a single waypoint from the User sub tab:

1. Use the **ROCKER** to highlight the waypoint you want to delete, and then press the **Delete Waypoint** soft key. A confirmation message appears.
2. Highlight **OK**, and press **ENTER** to delete the selected waypoint.

### To delete waypoints by symbol:

1. On the **User** sub tab, highlight the waypoint you want to delete.
2. Press the **Delete By Symbol** soft key.
3. Use the **ROCKER** to highlight the symbol of the waypoints you want to delete, and press **ENTER**.
4. Highlight **OK**, and press **ENTER** to delete the waypoints by symbol. Otherwise, highlight **Cancel**, and press **ENTER** to return to the User sub tab without deleting any waypoints.

### To delete all user waypoints:

1. On the **User** sub tab, press the **Delete All** soft key.
2. Highlight **OK**, and press **ENTER** to delete all user waypoints.

## Proximity Waypoints

Use the Proximity sub tab to define an alarm circle around a stored waypoint. The alarm circle can help you avoid reefs, rocks, or restricted waters. You can add proximity alarms to a maximum of 10 waypoints or on-screen map items, with a maximum alarm radius of 99.99 nautical or statute miles, or kilometers.

If a proximity alarm circle overlaps an existing alarm circle, the message “Proximity Overlaps Another Proximity Waypoint” appears. Because the unit only alerts for one of the overlap points, use caution when navigating in these areas. If your boat enters a red proximity circle overlap, you are alerted only to the closest proximity waypoint.

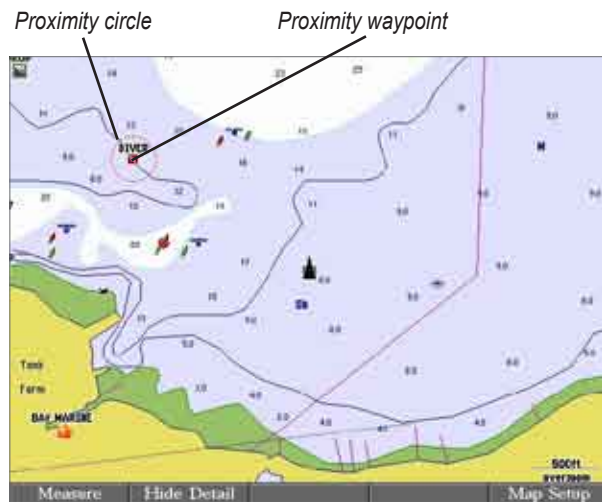

### To add a proximity waypoint:

1. Press the **New Alarm** soft key on the **Proximity** sub tab. The Find From Current Position Page appears.
2. Highlight a category, and press **ENTER**.
3. Use the **ROCKER** to highlight a waypoint or map item, and press **ENTER**. The Review Page appears for the selected waypoint or map item within a red circle.
4. Press the **OK** soft key. The Proximity sub tab appears with the **Distance** highlighted.
5. Press **ENTER**, and use the **ROCKER** to enter a proximity radius (up to 99.99 units).
6. Press **ENTER** when finished.

### To turn proximity alarms on or off:

1. Use the **ROCKER** to highlight the field below **Proximity Alarm** on the **Proximity** sub tab, and press **ENTER**.
2. Select **ON** or **OFF**, and press **ENTER**.

### To clear one or all proximity waypoints from the list:

1. Use the **ROCKER** to highlight the proximity waypoint you want to clear.
2. To clear a single alarm, press the **Delete** soft key.  
OR  
To clear all proximity waypoints, press the **Delete All** soft key. A confirmation message appears.
3. Press the **OK** soft key to delete the proximity waypoint. Otherwise, press the **Cancel** soft key, or press **QUIT** to cancel.

## Navigating to a Destination

Using the **NAV** key, the GPSMAP 3006C/3010C provides four ways to navigate to a destination: Go To Point, Follow Track, TracBack, and Follow Route.

When you are actively navigating, you see a straight line on the Map Page that always runs from your current location to the destination. The easiest method for selecting a destination is the Go To function, which allows you to select a destination point, and then set a direct course to it from your present location. If you highlight a point on a list or the map and press **NAV**, **Go To <point name>** appears in addition to **Go To Point**. The Go To function can be accessed from any list of points or from the map display.



Navigating to a Destination

### To Go To a point:

1. Press **NAV**.
2. Highlight **Go To Point**, and press **ENTER**. The Find From Current Position Page opens.
3. Highlight **Waypoints**, and press **ENTER**. (You can also choose to go to other points from this list, such as cities or tide stations.)
4. Select a waypoint, and press **ENTER** to open the Review Waypoint Page for the selected waypoint.
5. Press the **Go To** soft key to begin navigation. A magenta line appears on the map showing the course from your present location to the Go To point.

### To stop navigation:

1. Press **NAV**.
2. Highlight **Stop Navigation**, and press **ENTER**.

### Selecting a Map Item Go To Destination

A Go To can be used to select one of three items from the map—an existing waypoint, on-screen map items such as rivers, cities, nav aids, or a new map point. If you select a map item as the Go To destination, the GPSMAP 3006C/3010C automatically uses the name of the map item, but the point is not stored in the waypoint list. If you select a new map point (non-map item) as the Go To destination, the GPSMAP 3006C/3010C automatically creates a waypoint named **MAP** at the pointer location.

### To Go To an existing waypoint or map item from the map:

1. Use the **ROCKER** to highlight the waypoint or map item to which you want to navigate on the Map Page, and press **NAV**.
2. On the Navigation Menu, highlight **Go To <waypoint name>**, and press **ENTER**.



### To Go To a new map point (non-map item) from the map:

1. Use the **ROCKER** to move the pointer to the location you want to go to, and press **NAV**.
2. With **Go To MAP Point** highlighted, press **ENTER**.

### To stop navigation:

1. Press **NAV**.
2. Highlight **Stop Navigation**, and press **ENTER**.

### Follow Track and TracBack Navigation

A track is an electronic breadcrumb trail recording or history of your path. The track currently being recorded is the “active” track. An active track can be stored or saved in the unit. Both the Follow Track and TracBack options navigate in the same way. Follow Track uses stored or “saved” tracks; TracBack uses your current or “active” track.

TracBack allows you to retrace your path using the track log stored in the receiver’s memory, which eliminates the need to store waypoints along the way. TracBack routes are created by reducing your track log into a route and activating an inverted route. When active, a TracBack route leads you through your stored track log points, so it is a good idea to clear the existing track log before you start your current trip.

### To clear the track log:

1. Press and hold **ADJ/MENU** to open the Main Menu.
2. Using the **ROCKER**, highlight the **Tracks** tab, and then highlight the **Active** sub tab.
3. Press the **Clear** soft key. A confirmation message appears.
4. Press the **OK** soft key to clear the track log.

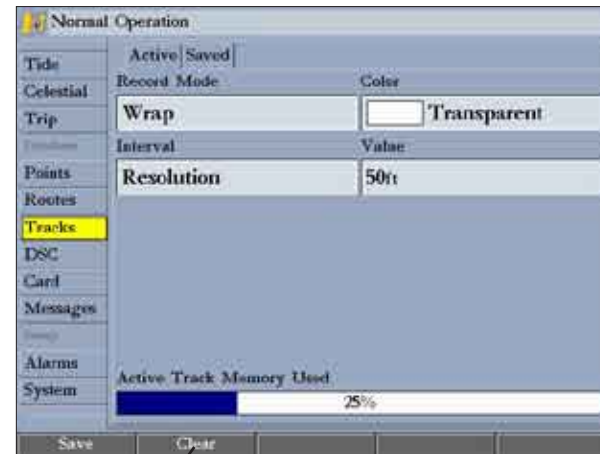

Clear soft key

## Saving a Track Log

You must save a track log before you can use the Follow Track feature. You can store up to 15 track logs from certain times and dates.

### To save a track log:

1. Press and hold **ADJ/MENU** to open the Main Menu.
2. Use the **ROCKER** to highlight the **Tracks** tab, and then highlight the **Active** sub tab.
3. Press the **Save** soft key, and press **ENTER**. The Save Back Through window appears.
4. Highlight the time or date of the track you want to save, or highlight **Entire Log**, and press **ENTER**. The track begins saving, and then the Saved Track Page appears. The default name, distance, number of points (700 maximum), and a map overview are shown.
5. To change the name of the saved track, highlight the **Name** field and press **ENTER**, make any changes, and press **ENTER** again.
6. To specify the color used to show the saved track line on the map and highway, highlight the **Color** field and press **ENTER**, choose a color, and press **ENTER** again.
7. To show the track on the Map and 3D Highway Pages, highlight the check box to the left of **Show on map and highway**, and press **ENTER**.
8. Press the **OK** soft key to save the track log.

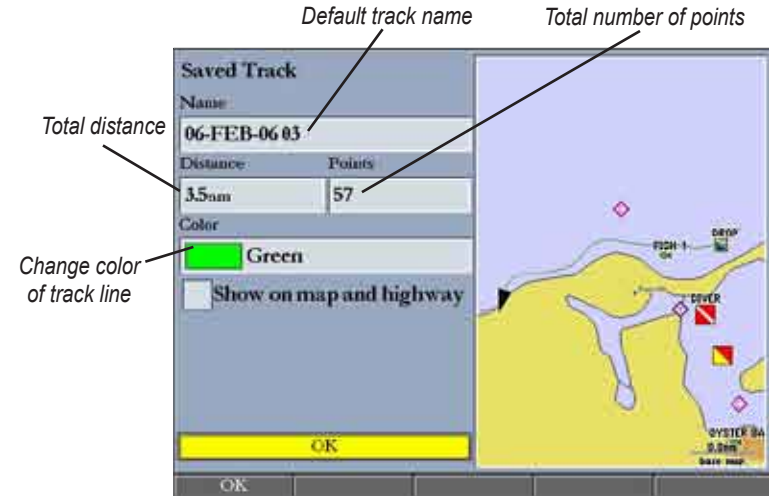

### To review and edit a track:

1. On the **Saved** sub tab, highlight a track and press **ENTER** to open the Saved Track Page.
2. Make any changes, and then press **QUIT**.

## Initiating a Follow Track

You must save a track before using the Follow Track option. If there are no saved tracks, the message “There are no Saved Tracks to follow” appears.

### To follow a track using the NAV key:

1. Press **NAV**, highlight **Follow Track**, and press **ENTER**. The Select Track Page appears.
2. Highlight the track you want to follow, and press **ENTER**.
3. To invert the Follow Track (navigate it in the reverse direction), press **NAV**, highlight **Invert Route**, and press **ENTER**.

### To start a TracBack using the NAV key:

1. Press **NAV** to open the **Navigation Menu**.
2. Highlight **TracBack**, and press **ENTER**. The TracBack Through window appears.
3. Highlight the time, date, or **Entire Log**, and press **ENTER**.

### To stop TracBack navigation:

1. Press **NAV**.
2. Highlight **Stop Navigation**, and press **ENTER**.

## TracBack Tips

When a TracBack is active, the GPSMAP 3006C/3010C takes the track log stored in memory and divides it into segments called legs. Up to 300 temporary turns (BEGIN, TURN 1, TURN 2, ..., TURN X, END) are created to mark the most significant features of the track log to duplicate your exact path as closely as possible. To get the most out of the TracBack feature, remember the following tips:

- Always clear the track log at the starting point.
- The Record Mode option on the track log setup page must be set to **Fill** or **Wrap**.
- At least two track log points must be stored in memory to create a TracBack route.
- If the track log Interval field is set to **Time**, the route may not follow your exact path (keep the interval set to **Resolution** for best performance).
- If the receiver is turned off or satellite coverage is lost during your trip, TracBack draws a straight line between any point where coverage was lost and where it resumed.
- If your track log's changes in distance and direction are too complex, 300 waypoints might not mark your path accurately. The receiver then assigns the 300 waypoints to the most significant points of your track, and simplifies segments with fewer changes in direction.



## Man OverBoard (MOB)

Use the Man OverBoard function to simultaneously mark and set a course to a location for quick response to emergency situations.

### To initiate the MOB function:

1. Press and hold the **NAV/MOB** key.
2. Press the **Yes** soft key to confirm and begin navigating to the MOB location.

When an MOB is initiated, an MOB waypoint with an international MOB symbol () is created, and the unit is on an active navigation to that point. Use any of the navigation pages to guide you back to the MOB point. The MOB waypoint is stored in the waypoint list, and you can delete or edit it like any other waypoint.



### To stop navigation to the MOB location:

1. Press **NAV/MOB** to open the **Navigation Menu**.
2. Highlight **Stop Navigation**, and press **ENTER**.



## Creating and Using Routes

You can create and store up to 50 reversible routes (numbered 1–50), with up to 300 points each.

### Creating a New Route

Using the Route tab on the Main Menu, you can create a new route in one of two ways. You can select waypoints or map items on the map window, allowing you to see each route point on the screen as you create the route, or you can select waypoints from the waypoint list, allowing you to see a list of the route points as you create the route.

### To create a new route using the map window:

1. Press and hold **ADJ/MENU** to open the Main Menu.
2. Use the **ROCKER** to highlight the **Routes** tab.
3. Press the **New Route** soft key. The Route map window appears, and the position marker () changes to the map pointer () with "ADD" underneath it.
4. Use the **ROCKER** to highlight the location you want to add to your route, and press **ENTER**. As you add each new waypoint to the route, the upper-left corner of the screen shows the waypoint name. The bottom of the screen shows you the number of available points. Repeat this step until you finish defining all route waypoints.



**NOTE:** If you select an area of the map that is not a feature or waypoint, a new waypoint is created for that location.



Waypoint	Distance	Course	ETA
RAMP	0.0nm		08:51AM
"0"	0.2nm	094°M	08:52AM
DIVER	0.3nm	355°M	08:52AM
	—nm	—°M	—AM

0.3nm 063°M 08:52AM

Use Map Add Distance Rename Plan

Route List with Information

### To create a new route using the Route list:

1. Press and hold **ADJ/MENU** to open the Main Menu.
2. Use the **ROCKER** to highlight the **Routes** tab.
3. Press the **New Route** soft key to open the Route map window.
4. Press the **Use List** soft key to open the Route list.
5. Use the **ROCKER** to highlight the first field under the word "Waypoint", and press **ENTER**. The Find From Current Position Page appears.
6. Highlight **Waypoints**, and press **ENTER**. (You can also choose from other points, such as cities or nav aids.)
7. Select a waypoint to add to the route, and press **ENTER**. The Review Waypoint Page appears.
8. Press the **OK** soft key to add the point to the route. As you add each new waypoint to the route, the Route list shows the waypoint or map item name, leg distance, course between points, and a selectable column to show other route information.

9. Repeat steps 5–8 until all route points are entered. Press **QUIT** to return to the Route Page.

### Navigating a Saved Route

After you create a route, press the **NAV** key to navigate it. You can follow a route in the same sequence as it was originally created, invert and follow the route from the end point back to the beginning point, or re-evaluate it.

#### To navigate a saved route:

1. From any page, press **NAV**, and then highlight **Follow Route** on the Navigation Menu.
2. Press the **Pick Saved** soft key to select a saved route. The Select Route window opens.
3. Use the **ROCKER** to highlight the route you want to navigate, and press **ENTER**. The selected route is shown on the Map Page.



**To stop navigating a route:**

Press **NAV**, highlight **Stop Navigation** on the Navigation Menu, and press **ENTER**.

The following options are available on the Navigation Menu by pressing **NAV** while navigating a route:

- **Invert Route**—reverses the route so you can follow it from the end point back to the beginning.
- **Re-Evaluate Route**—recalculates and reactivates the current route data; and it selects the route leg closest to your current location as the active leg (the active leg defines the current from and to waypoints).

**Creating a Quick NAV Route**

Use the **Create QUICK** soft key to create a quick route that you can begin navigating immediately.

**To create and navigate a QUICK NAV route:**

1. Press **NAV/MOB**, and highlight **Follow Route**.
2. Press the **Create QUICK** soft key.
3. Use the map pointer to select a waypoint or map item, and press **ENTER**.

As you add each new waypoint to the route, the data window at the top of the Map Page shows the waypoint or map item name, bearing and distance from your location, and coordinates of the map pointer. The bottom of the screen shows the number of available points. A route line appears on the map to indicate each completed leg, and a dotted line appears indicating the distance and bearing to the arrow pointer from the last route waypoint.

4. Repeat step 3 until you finish adding all route waypoints.
5. Press **QUIT** twice to start your Quick NAV route.

**Copying a Route**

Use the **Copy** soft key on the Route tab to copy an existing route.

**To copy a route:**

1. Press and hold **ADJ/MENU** to open the Main Menu, and then highlight the **Routes** tab.
2. Use the **ROCKER** to select the route you want to copy, and press the **Copy** soft key. The map window for the new route opens. The copied route uses the same route name with an additional number (starting at 1) at the end of the route name.

## Deleting a Route

Use the Route tab on the Main Menu to delete an individual route or delete all routes.

### To delete an individual route:

1. Press and hold **ADJ/MENU** to open the Main Menu, and then highlight the **Routes** tab.
2. Use the **ROCKER** to select the route you want to delete, and then press the **Delete** soft key. A confirmation message appears.
3. Highlight **OK**, and press **ENTER** to delete the route.

### To delete all routes:

1. Press and hold **ADJ/MENU** to open the Main Menu, and then highlight the **Routes** tab.
2. Press the **Delete All** soft key. A confirmation message appears.
3. Highlight **OK**, and press **ENTER** to delete all routes.

## Editing a Route

After you create or copy a route, use the Route tab to add, edit, or delete points from a route or rename a route.

### To change the name of a route:

1. On the **Routes** tab, highlight the route you want to edit, and press **ENTER**. The map window opens showing the selected route.
2. Press the **Rename Route** soft key. The first character in the **Editing Route** field is highlighted.

Editing  
Route field

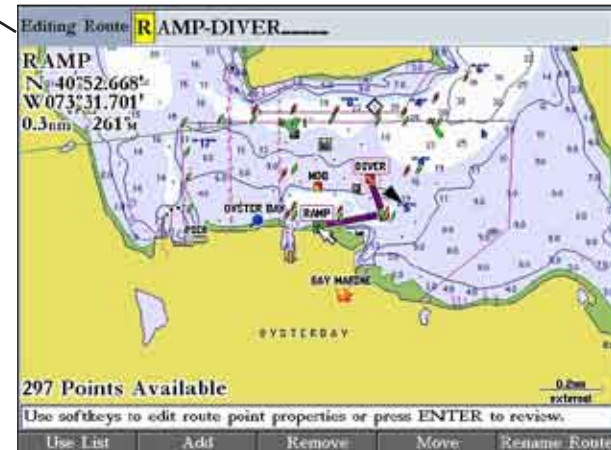

3. Use the **ROCKER** or data entry keys to change the route name, and press **ENTER** when finished.

**To review individual route points on the map:**

1. On the **Routes** tab, highlight the route you want to edit, and press **ENTER**. The map window opens showing the selected route.
2. Highlight a point on the route, and press **ENTER** to open the Review Waypoint Page.



**Review Waypoint Page**

3. Press the **Rmv From Rt** soft key to remove the point from the route, press the **Move Wpt** soft key to move the waypoint, press the **Delete** soft key to permanently delete the waypoint from the unit, or press the **Next** soft key to highlight the next point on the route list. If the selected route point is a user waypoint, you can edit any of the waypoint properties on the Review Waypoint Page.

**To add points to a route:**

1. On the **Routes** tab, highlight the route you want to edit, and press **ENTER**. The map window opens showing the selected route.
2. Move the map pointer to the leg of the route where you want to add the new point. The selected route leg turns yellow.

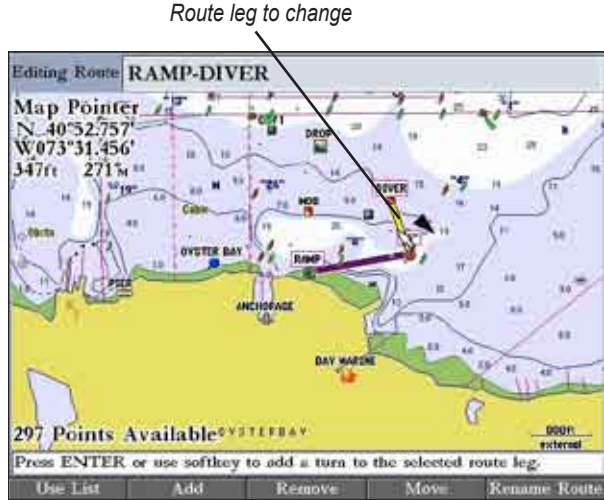

3. Press the **Add** soft key. The color of the selected route leg changes to magenta and the word "ADD" appears below the map pointer.

- Use the **ROCKER** to drag the map pointer to the location where you want to add a route point.
- Press **ENTER** to add the point to the route.



#### To remove a point from a route:

- On the **Routes** tab, highlight the route you want to edit, and press **ENTER**. The map window opens showing the selected route.
- Select the point you want to remove from the route, and press the **Remove** soft key.

#### To graphically edit a route on the map:

- On the **Routes** tab, highlight the route you want to edit, and press **ENTER**. The map window opens showing the selected route.
- Use the **ROCKER** to highlight a point to review (waypoint or map item).
- Press the **Move** soft key to move the selected point. The word "MOVE" appears below the map pointer.

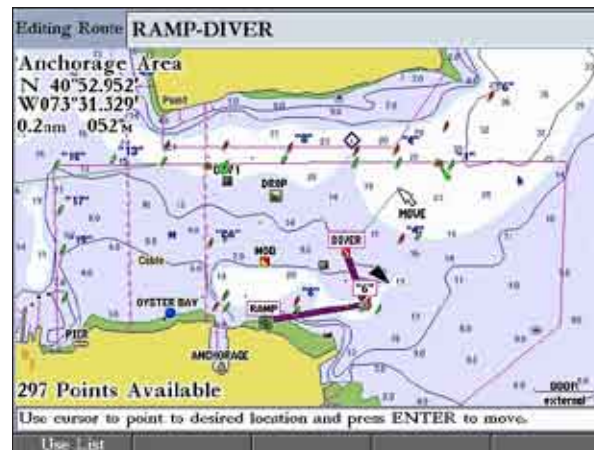

- Use the **ROCKER** to drag the map pointer to the location where you want to move the route point, and then press **ENTER** to move the route point.

### Planning Routes

You can enter information on the Plan Route window such as your speed, departure time, fuel flow, and departure date so your GPSMAP 3006C/3010C can estimate information about your trip.

#### To plan your route:

1. Press the **Plan** soft key on the Route list to open the Plan Route window.
2. Enter planning data for speed and fuel flow. You can also enter the date and time of your departure. As you enter planning information, the fields on the Route list are automatically calculated.



**NOTE:** Fuel flow rates are measured in units per hour. System setting changes for units of measure (statute, nautical, or metric) do not affect the fuel flow measure. You should enter fuel flow rates based on available information for your boat (operators manual, performance specifications) and note the units of measure (gallons, liters, and so on).

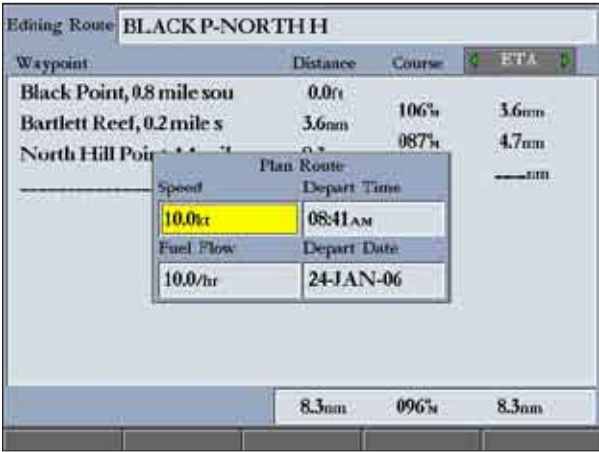

3. Press **QUIT** to return to the Route list.

#### To change the data column (Plan Route feature):

1. On the Route list, highlight the adjustment button to the right of the **Course** column header, and press **ENTER**. The middle title is highlighted.

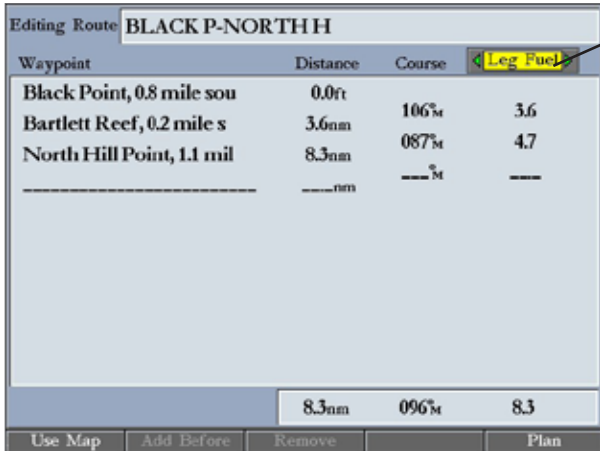

Planning features

2. Press left or right on the **ROCKER** to select one of eight available planning features, including **ETA** (Estimated Time of Arrival at point), **Fuel** (to point), **Leg Dist**, **Leg Fuel**, **Leg Time**, **Sunrise**, **Sunset** (at point location), and **Time To** (point).  
The unit automatically recalculates each waypoint in the route based on the planning feature selected.
3. Press **ENTER** when you are finished.

## MAIN PAGES

The GPSMAP 3006C/3010C has four main pages that are always available by default: Map Page, Map Split Page, Compass Page, and 3D Highway Page. An optional main page, the Video Page, appears if you are inputting a video signal. Press **PAGE** to cycle through the main pages in order. If you have a GSD 20, GSD 21, or GSD 22 with a transducer connected to the GPSMAP 3006C/3010C, a Sonar Page is added into the page sequence.

When the unit is turned on, the Map Page appears. As you add optional hardware to the GPSMAP 3006C/3010C or Garmin Marine Network, additional main pages, functions, or adjustments may appear automatically. For specific information about additional main page operations, refer to the documentation provided with the optional hardware.

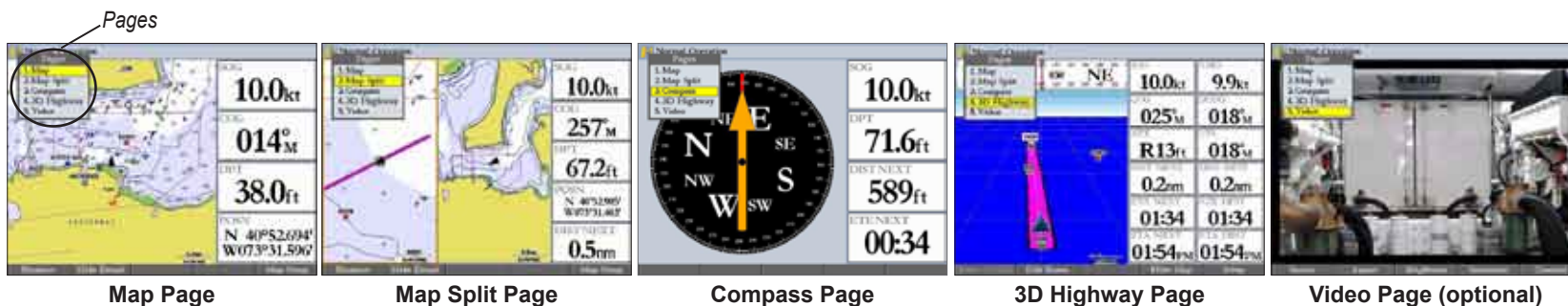

### To go to a specific main page:

1. Press **PAGE**. The Pages Menu shows the list of available main pages and their corresponding shortcut numbers. The active main page is highlighted.
2. Press up or down on the **ROCKER** to highlight a main page, or press the data entry key that corresponds to the shortcut number of the main page you want to view, and press **ENTER**.



## Configuring Main Pages

You can customize each main page to fit your navigational needs, and you can modify digital data fields and add additional secondary functions to each of the main pages. As you add optional hardware to your GPSMAP 3006C/3010C or Garmin Marine Network, additional function choices might appear automatically.

You can also show other functions, such as a compass, temperature log (if inputting Garmin or NMEA sonar data), or a second map (Map Page only). Digital data fields (Digital 1 and Digital 2) can be changed in size and type of data that is shown in each data field. As you add or remove functions and data fields, a preview window shows the layout.

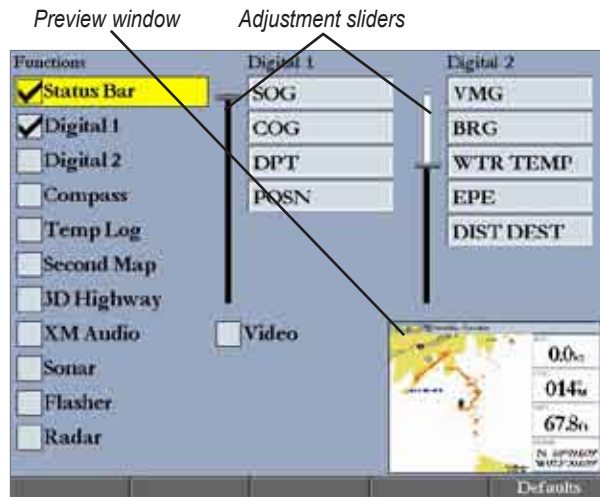

Configuration Window

### To add or remove functions on a main page:

1. Press and hold **DATA/CNFG** to open the Configuration window.
2. Using the **ROCKER**, highlight the function you want to add or remove, and press **ENTER**. Only functions with a check mark in the check box to the left of the name appear on the main page. The main page to which you are adding functions always appears either on the left side (two or three function windows) or in the upper-left (four or more function windows).
3. When finished, press **QUIT** to return to the main page.

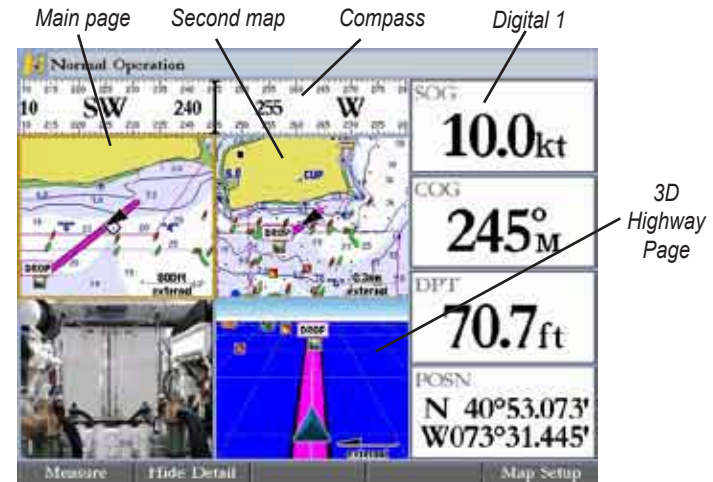

Map Page with Additional Functions

### To change the size of the Digital data fields:

1. Press and hold **DATA/CNFG** to open the Configuration window.
2. Using the **ROCKER**, highlight the **Digital 1** or **Digital 2** adjustment slider, and press **ENTER**.

- Press up on the **ROCKER** to display larger text with fewer data fields; press down on the **ROCKER** to display smaller text with more data fields. A preview of the data fields appears in the preview window. As you adjust the data field size, the configurable data fields automatically appear in the Digital 1 and Digital 2 lists.
- Press **QUIT** to exit the slider adjustment. Press **QUIT** again to return to the main page.



**To change Digital 1 or Digital 2 data fields:**

- Press and hold **DATA/CNFG** to open the Configuration window.
- Highlight the data field you want to change, and press **ENTER**.

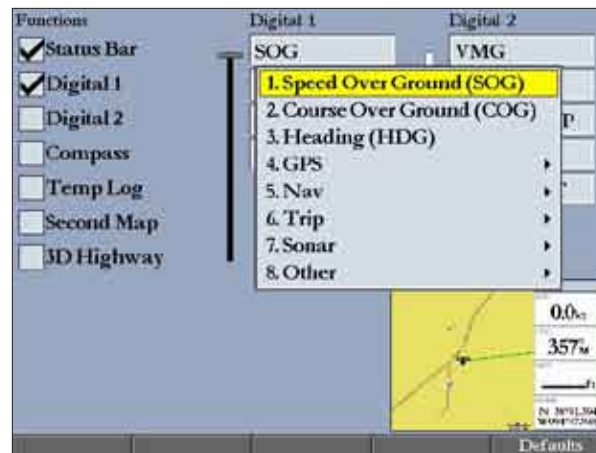

- Press up or down on the **ROCKER** to highlight the type of data you want to show, and press **ENTER**.
- Press **QUIT** to exit.

**To restore the factory default configuration:**

- Press and hold **DATA/CNFG** to open the Configuration window.
- Press the **Defaults** soft key.

## Using Function Windows

You can add additional function windows to any of the main pages. After you configure a main page, press **FCTN** to cycle through the available function windows. The active function window is highlighted with a yellow box. Each time you press **FCTN**, the highlight moves in a clockwise motion (when three or more function windows are shown).



### To cycle through function windows on a main page:

1. Press **FCTN**. The **Functions Menu** appears with the next function on the list highlighted.
2. Each time you press **FCTN**, the next function window is highlighted. Press **ENTER** when the function window you want is highlighted. Functions that are not available appear dimmed and cannot be selected.

## Function Window Adjustments

Each active function window (except the Compass) has specific adjustment (**ADJ** key)/soft key options and main page features. You can use options from the adjustment menu or soft keys to access adjustments or features for the active (highlighted) function window. As you add optional hardware to your GPSMAP 3006C/3010C or Garmin Marine Network, adjustment menu choices may appear automatically. For specific instructions on adjustments and features for the highlighted window, refer to the specific section (or manual) for that main page.

### To show adjustment options for the active function window:

1. Press **ADJ**. The adjustment menu appears for the highlighted or active function window.
2. Press the data entry shortcut key, or use the **ROCKER** to highlight an option, and press **ENTER**.



## Viewing a Main Page in Full-Screen Mode

Use the **DATA** key to view the main page in full-screen mode, without functions, the status bar, or Digital Data fields. Press **DATA** again to return to the previous view.



Map Page in Full-Screen Mode

## Map Page

The Map Page provides comprehensive electronic cartography, plotting, and navigational data. When using the GPSMAP 3006C/3010C with the optional BlueChart data or MapSource maps, the map display shows your boat on a digital chart, complete with geographic names, map items, nav aids, and other chart features. You can use the optional preprogrammed BlueChart g2 data cards with your GPSMAP 3006C/3010C to view detailed roads and photographs.

When the map pointer is active, information appears in the upper-left corner of the map to indicate location, any identifying text, range, and bearing to the pointer or a selected waypoint or map item. The map zoom range is shown in the lower-right corner of the map.

Map information

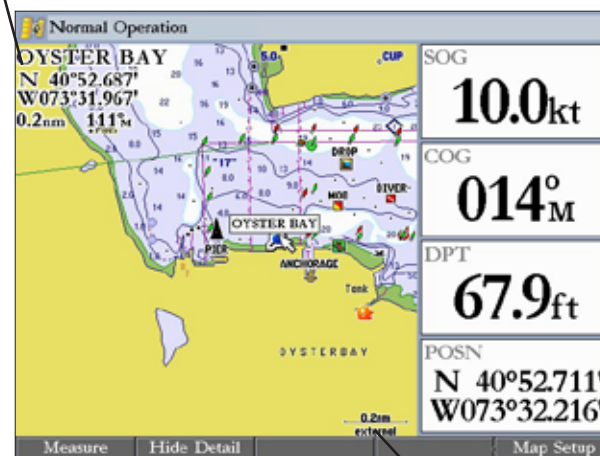

Map zoom range

Use the **RANGE Up** and **RANGE Down** keys and the **ROCKER** to select zoom ranges and move the map pointer. Two basic map operating modes, Position Mode and Pointer Mode, determine what cartography (map data) is shown on the Map Page. Position Mode pans the cartography to keep the current position marker within the display area, whereas Pointer Mode pans the cartography to keep the map pointer within the display area.

The GPSMAP 3006C/3010C starts in Position Mode, with your location centered on the map.

Press up, down, left, or right on the **ROCKER** to enter Pointer Mode. In Pointer Mode:

- You can move the map pointer over the map using the **ROCKER**.
- When the map pointer reaches the edge of the display, the map scrolls forward under the pointer. Keep in mind that the boat icon moves with the map scrolling and may go off the screen (you might not be able to see your current location).
- When the map pointer is stationary, a fixed coordinate location appears in the position field. The distance and bearing change as the boat's location changes.
- When you change the range in Pointer Mode, the map pointer is centered on the screen.
- To return to Position Mode, press **QUIT**.



**NOTE:** When the map pointer reaches the edge of the map, the unit may pause as it loads new map data.

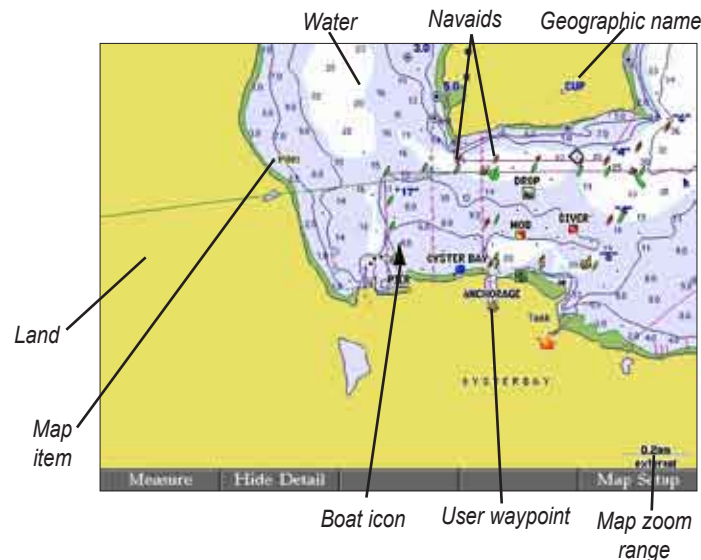

### Selecting Map Ranges

The map has 28 available range scales from 20 ft to 800 mi (5 m to 1,200 km). The map zoom range is controlled by the **RANGE Up** and **RANGE Down** keys, with the current range shown at the lower-right corner of the Map Page.

#### To select a map range:

Press the **RANGE Up** key to zoom out or the **RANGE Down** key to zoom in.



**NOTE:** The scale value represents the distance from one end of the scale bar to the other.

## Cartography

The GPSMAP 3006C/3010C has a built-in worldwide database, with more detailed coverage available through the use of optional BlueChart or MapSource data. The unit shows cartography as long as chart information is available for the selected range.

The GPSMAP 3006C/3010C accepts preprogrammed data cards and is compatible with the latest BlueChart g2 series marine cartography, which features integrated mapping, 2-D or 3-D map perspective, tide and current data, improved IALA symbols, nav aids, marinas, boat ramps, and roads.



**BlueChart g2 Cartography**

Map coverage conforms to the following conditions:

- Cartography appears when the selected map zoom range is covered by either the internal database, BlueChart, or BlueChart g2 data.
- When the selected map zoom range is covered by both the internal database and BlueChart or BlueChart g2 data, the cartography with the best resolution appears.
- When the selected map zoom range exceeds the resolution of the data in use, overzoom cartography appears and an overzoom warning appears below the range.

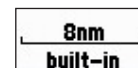

**Using Built-In Basemap**

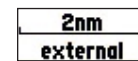

**Using BlueChart/BlueChart g2/MapSource Data**



**Overzoom, No Additional Data**



**NOTE:** The GPSMAP 3006C/3010C is not compatible with Garmin BlueChart g2 Vision mapping data.

## Map Page Options

The Map Page provides access to functions and features relating to the Map Page (or Map function window) using the **ADJ** key and soft key options. The available options are: **Measure (Distance)**, **Hide (Show) Detail**, and **Setup**. As you add optional hardware to the chartplotter or Garmin Marine Network, additional adjustment menu choices may appear automatically.

You can customize the Map Page to show other functions and different sizes or types of Digital Data fields.

### Measuring Distance

Use the **Measure (Distance)** option to measure the distance and bearing between two points.

#### To measure the distance and bearing between two points:

1. Press the **Measure** soft key. An on-screen pointer appears on the map display at your present location with a blue thumbtack symbol to show the "From" reference point.
2. Using the **ROCKER**, move the pointer to the reference point (the point from which you want to measure), and press **ENTER**. The blue thumbtack symbol now appears at that point.
3. Move the pointer to the point from which you want to measure. The bearing and distance from the reference point and pointer coordinates appear in the upper-left corner of the Map Page.
4. Press **QUIT** to finish.



Measuring Distance  
(BlueChart Data Shown)

### Hiding and Showing Map Details

Use the **Hide Detail (Show Detail)** soft key to show or hide Spot Soundings and Map Outlines for easier viewing.



**NOTE:** This setting only affects the currently selected map. If you have a second map window shown, you can set one map to show detail and one map to hide detail.

### To hide (show) map details:

Press the **Show Detail** soft key to show map details; press the **Hide Detail** soft key to hide map details.

Spot Soundings  
(BlueChart data)



Map with Detail Shown



Map Page with Detail Hidden

### Changing Map Setup Features

You can configure the map display preferences, including map detail, map orientation, automatic zoom, and various map items and points. When you select **Map Setup**, the Main Menu appears with the **Map** tab selected. The setup options are arranged in a horizontal, easy-to-use sub tab format, making it easier to organize and use the various settings. Changes made from the Map Setup option affect all maps.

#### To change a Setup feature:

1. Press the **Map Setup** soft key. The Main Menu appears with the Map tab highlighted.

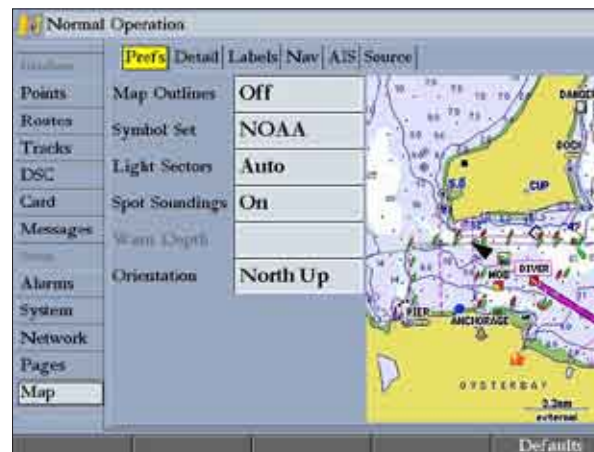

2. Press left or right on the **ROCKER** to highlight a sub tab, press up or down to highlight the setting you want to change, and press **ENTER**.
3. Press up or down on the **ROCKER** to select a different setting, and press **ENTER**.



## Map Split Page

Use the Map Split Page to view two pages at the same time. You can show two different views of the Map Page, or to show a split view of the Map and 3D Highway pages. If you have a Garmin sonar module connected, you can set up the Map Split Page to show the Map Page and Sonar Page; if you have Garmin radar connected, you can view both the Map Page and the Radar Page.



### To configure the Map Split Page:

1. Press **PAGE** until the Map Split Page is shown.
2. Press and hold the **DATA/CNFG** key to open the Functions window.
3. Select the pages and options you want to show on the Map Split Page.
4. Press **QUIT** to close the Function window and return to the Map Split Page.

## Compass Page

The GPSMAP 3006C/3010C features two different navigation pages: Compass and Highway. Whenever you are following a route or TracBack, the Compass Page guides you to your destination with digital readouts and a compass display, which includes a Bearing Pointer.

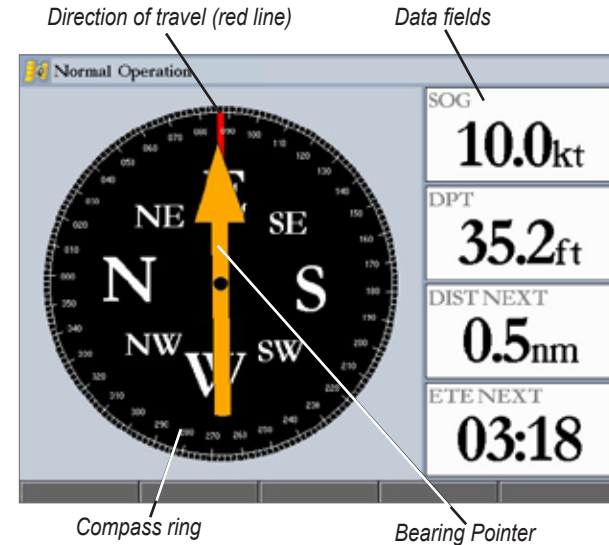

For the compass to work, the GPS must be moving. When you are moving, the orange Bearing Pointer points toward your destination, while the Compass Ring reflects the direction you are traveling by a red vertical line at the top of the Compass ring. When you are headed directly toward your destination, the Bearing Pointer points toward the top of the screen, aligned with the red vertical line at the top of the Compass ring. If you are not heading toward your destination, the Bearing Pointer turns, continuing to point toward your destination. To head toward your destination, turn until the Bearing Pointer is aligned with the red vertical line in the Compass ring.

Along the right side of the screen are the default data fields; the top field is speed. Also shown are the distance to your waypoint (DIST NEXT) and estimated time en route (ETE NEXT). The distance and en route time decrease as you near your destination.

The Bearing Pointer or Compass ring may point in various directions when you are stationary or at very low speeds. When you start moving, the pointer is correct.

You can customize the Compass Page to show other functions and different sizes or types of Digital Data fields.

### 3D Highway Page

The 3D Highway Page provides 3-D graphic steering guidance to a destination waypoint, placing greater emphasis on the straight-line course, and the distance and direction you are off course. As you head toward your destination, the middle of the screen guides you to your waypoint on a moving highway. Your present location is at the bottom-center of the 3D Highway Page. Three-dimensional cartography provides situational awareness while navigating. The line down the middle of the highway represents your course.

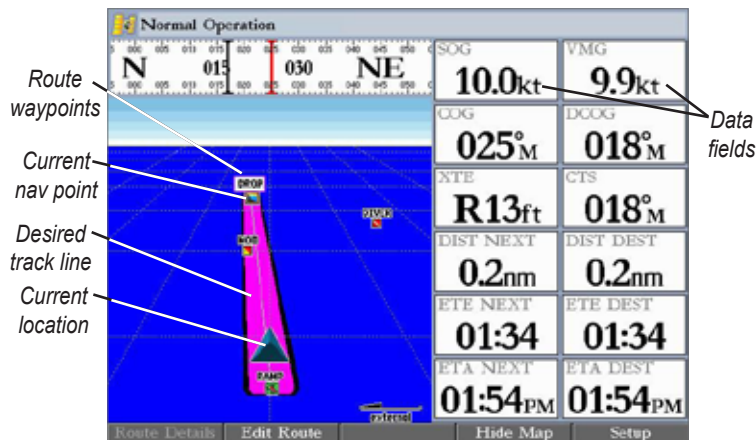

As you head toward your destination, the highway perspective moves to indicate your progress to the waypoint and which direction you should steer to stay on course. If you are navigating a route, the 3D Highway Page shows each route waypoint in sequence connected by a magenta “road” with a line down the middle. As you navigate toward a waypoint, the highway moves, indicating the direction you are off course. To stay on course, steer toward the center of the highway. You can also view Routes details, nearby waypoints not in the active route, Track Log points, and Saved Tracks.

### Changing the Highway Perspective Range

You can zoom the highway perspective range in or out to show a larger or smaller view of the highway.

#### To change the highway perspective range:

Press the **RANGE Up** key to zoom out, or press the **RANGE Down** key to zoom in.

### 3D Highway Page Options

The 3D Highway Page provides access to functions and features relating to the 3D Highway Page (or Highway function window) using the **ADJ** key and soft key options.

The available **ADJ** soft key options are **Route Details**, **Edit Active Route**, and **Setup**. As you add optional hardware to your GPSMAP 3006C/3010C or Garmin Marine Network, adjustment menu choices may appear automatically. You can also customize the 3D Highway Page to show other functions and different sizes or types of Digital Data fields.

- **Active Route Details (Route Details)**—shows details such as distance, course, and other useful information for each waypoint of the active route.
- **Edit Active Route (Edit Route)**—allows you to review and modify the Active Route from either a list of the route points or on a map.
- **Setup**—allows you to select what waypoints and tracks are shown on the 3D Highway Page. Use the **ROCKER** and **ENTER** keys to select or clear options. The following options are available:
  - **Active Route Waypoints**—shows all active route waypoints.
  - **User Waypoints**—shows only nearby waypoints.
  - **Track Log**—shows the current active track log.
  - **Saved Tracks**—shows any saved track logs.

### Showing or Hiding Maps

When using optional preprogrammed BlueChart g2 data cards, you can view the map on the 3D Highway Page.



**NOTE:** The Show/Hide Map feature is available only if you are using an optional preloaded BlueChart g2 data card.

#### To view map on the 3D Highway Page:

Press the **Show Map** soft key to show the map cartography on the 3D Highway Page. Press **Hide Map** to return to the highway view.

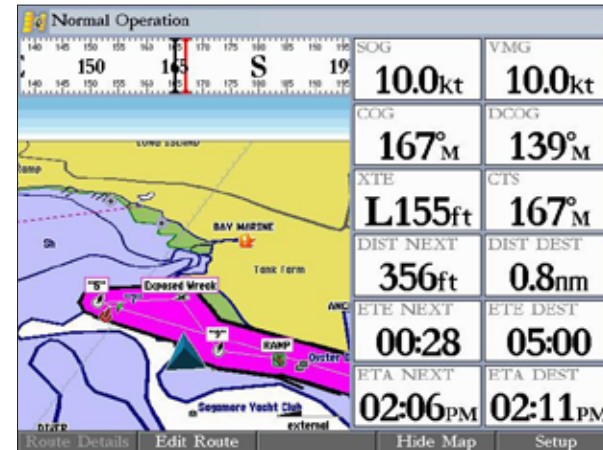

Show/Hide Map (Using Optional BlueChart g2)

## Video Page

The Video Page is available only if you attach an optional NTSC (National Television System Committee) or PAL (Phase Alternate Line) composite video source to the GPSMAP 3006C/3010C (see the *GPSMAP 3006C/3010C & GPS 17 Installation Instructions* for more information). You can input up to two different video signals to your GPSMAP 3006C/3010C. When attached, you can change or alternate between video sources, and adjust the aspect, brightness, saturation, and contrast. You can also adjust which video standard is being input.



## Video Page Options

Use the **ADJ** key and soft keys to access the following options: **Source**, **Aspect**, **Brightness**, **Saturation**, **Contrast**, and **Standard**.

- **Source**—select input between **Video In 1** and **Video In 2**. Choose **Alternate** to switch between sources at 5, 10, and 30 second intervals.
- **Aspect**—select **Stretch** to stretch the video input to fill the entire frame, or select **Standard** to show the normal view of the video input.
- **Brightness**—affects how bright the overall video input appears on the display (0%–100%).
- **Saturation**—adjusts the intensity of the colors. High saturation produces bright colors, whereas low saturation produces washed out colors.
- **Contrast**—adjusts the difference between light and dark areas of the video input. The higher the contrast, the brighter the video appears.
- **Standard (ADJ key only)**—selects the composite video input standard. Choose **Auto** to have the unit automatically select the Standard. Choose **NTSC** for composite video in NTSC standard or **PAL** for composite video input in PAL standard. If set to **Auto** and **Alternate** is selected as the Source, you might notice a switching display as the unit determines the video input. For best results, set to the specific Standard.

## MAIN MENU

The Main Menu provides access to various waypoint, system, navigation and interface management, and setup menus in an easy-to-use tab format. The Main Menu is accessible from any page by pressing **ADJ/MENU**. As you add optional hardware to your GPSMAP 3006C/3010C or the Garmin Marine Network, additional Main Menu tabs or sub tabs may appear automatically. For specific instructions on additional adjustments and features, refer to the specific section (or manual) for that hardware device.

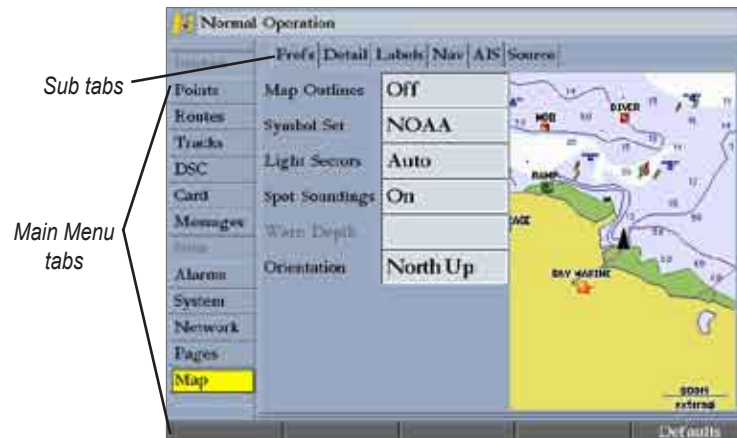

## GPS Tab

The GPS tab provides a visual reference of satellite acquisition, receiver status, and accuracy. The sky view and signal strength bars give you an indication of what satellites are visible to the receiver and whether or not they are being tracked. For more information about GPS, see [pages 6-7](#). For more information about WAAS, see [page 103](#).



### To select a tab from the Main Menu:

1. Press and hold **ADJ/MENU** to open the Main Menu.
2. Press up or down on the **ROCKER** to highlight the tab you want to view. (The highlight wraps around when you reach the top or bottom of the list.) The information for the highlighted tab automatically appears to the right. If you want to highlight any of the sub tabs, press left or right on the **ROCKER**, and then press up or down to select individual fields.

## Tide Tab

Use the Tide tab to view tide and current information. The Tide tab contains two sub tabs: Tide and Current.

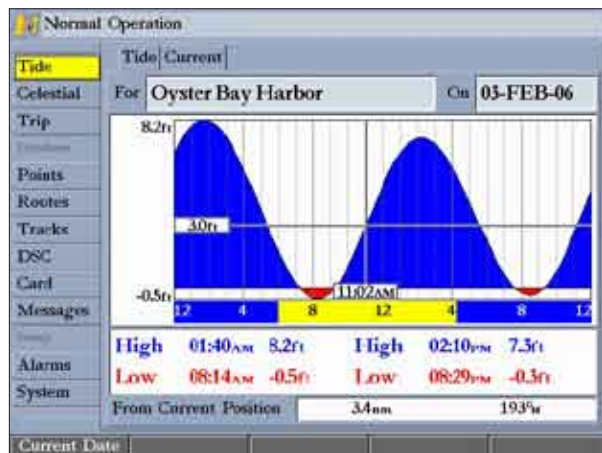

in 1-hour increments. A solid, vertical line (with the local time at the top) indicates the tide height corresponding to the time shown in the local time box.

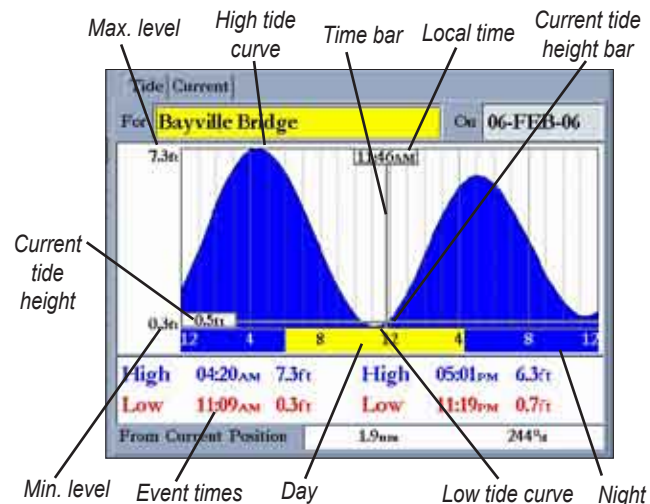

### Tide Sub Tab

The Tide sub tab contains a graphical chart that shows Tide Station information in a 24-hour span starting at midnight. You can choose from different dates and more than 3,000 Tide Stations around the USA coastline, Alaska, Hawaii, western Canada, and several of the Caribbean islands. The top of the Tide sub tab shows the Tide Station and the date. The bottom of the Tide sub tab shows the distance and bearing from your location.

The bottom of the Tide chart shows a 24-hour block of local time for your location. Daylight (yellow bar) and nighttime (blue bar) at the Tide Station are shown across the time scale, with the time progressing from left to right (sunrise and sunset information might not be available for some Tide Stations). The solid, light vertical lines are in 4-hour increments, and the light, dotted vertical lines are

The Tide curve is shown as a shaded area, where higher tides are taller (blue) and lower tides are shorter (red). The solid, horizontal line indicates the tide height. The figure to the left of the line shows the present tide level. The Mean Lower Low Water (MLLW) appears as a solid, horizontal line near the bottom of the chart (this line appears only if the tide height range is zero or below). The numbers on the top and bottom of the left side indicate the maximum and minimum levels. The four data fields below the chart indicate event times and levels at which the tide changes, starting in the upper-left field, going downward, then to the upper-right, and down again. When comparing with other tide tables, verify that the depth unit's value is the same for both sources. The bottom of the chart shows the amount of time (in hours and minutes) until the next low tide and high tide.

**To select the Tide Station nearest to your location:**

1. Highlight the **For** field, and press **ENTER** to open the Find Tides Page.
2. Highlight **Current Position**, and press **ENTER** to open the Find Near Current Position Page.
3. Select a Tide Station from the list, and press **ENTER**. As you move the highlight over each Tide Station in the list, the station is highlighted on the map window. The distance and bearing from your location to the highlighted Tide Station are shown at the bottom of the list.

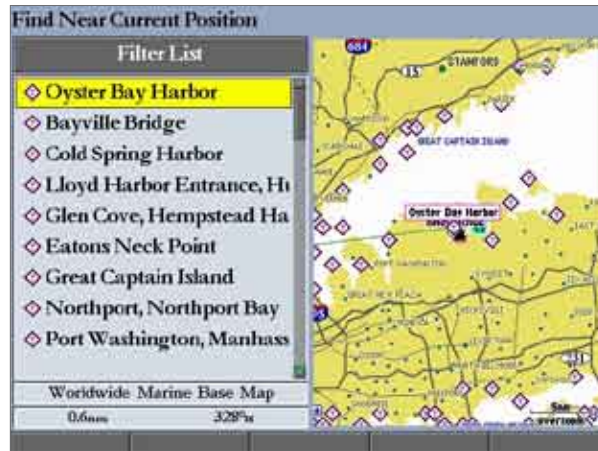
**Tide Stations Near Your Location**

If you are not within this range, the message “None Found” appears. Use the Map Position option to select a location closer to a Tide Station.

**To select a Tide Station from a map location:**

1. Highlight the **For** field, and press **ENTER** to open the Find Tides Page.
2. Highlight **Map Position**, and press **ENTER** to open the Find Near Current Position Page.

3. Press up or down on the **ROCKER** to move the map pointer to a map location, and press **ENTER**. The Find Near Other Position Page shows a list of Tide Stations near the selected map location.
4. Select a Tide Station, and press **ENTER**. If the “None Found” message appears, repeat steps 1–3 until you find a Tide Station.

**Viewing Tide Information**

You can change the date to see tide charts for other days or move the time bar in approximately 5- minute increments to show tide heights at various times.

**To change the date of the tide chart:**

1. Using the **ROCKER**, highlight the **On** field, and press **ENTER**.
2. Enter a date, and press **ENTER**. The tide chart is updated to show tide information for the selected date.
3. Press the **Current Date** soft key to return.

**To view tide heights at various times on the tide chart:**

1. Highlight the tide chart.
2. Press left or right on the **ROCKER** to change the time and day. The day changes as you move past the edge of the tide chart.

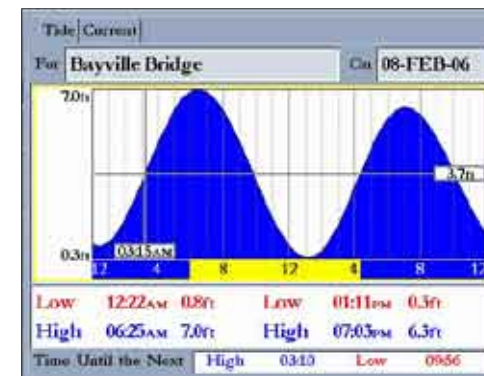

## Current Sub Tab

The Current sub tab shows information for currents in a 24-hour span, starting at midnight. You can choose from different dates and more than 3,000 Current Stations around the USA coastline, Alaska, Hawaii, western Canada, and several of the Caribbean islands. The top of the Current sub tab shows the Current Station and the date. The bottom of the tab shows the distance and bearing from your location.

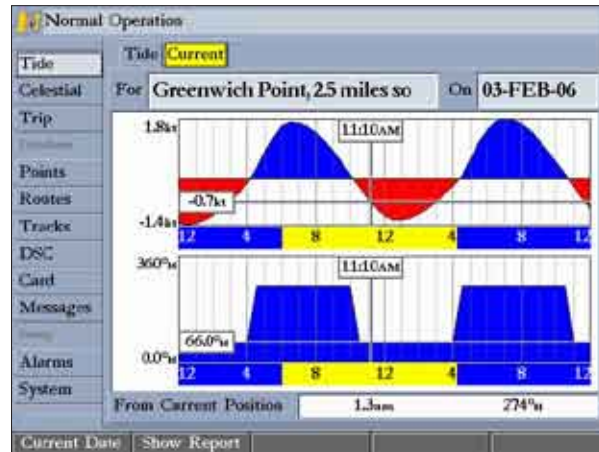

The Current sub tab contains two charts, one for speed and one for direction.

The top chart is the speed chart, which shows the speed of a given current at any point during the day. The shaded area is blue (Flood Current) when the current is heading toward shore; the shaded area is red (Ebb Current) when the current is heading away from shore.

The bottom chart is the direction chart, which shows the direction of the current at any given point during the day (based on the north reference, not true north).

The bottom of each chart shows a 24-hour block of local time for your location. Day (yellow bar) and night (blue bar) at the Current Station appear across the time scale, with the time progressing from left to right (sunrise and sunset information may not be available for some stations). The solid, light vertical lines are in 4-hour increments, and the light, dotted vertical lines are in 1-hour increments. A solid, vertical line (with the local time at the top) indicates the strength of the current that corresponds to the time shown in the local time box.

### To select the Current Station nearest to your location:

1. Highlight the **For** field, and press **ENTER** to open the Find Currents Page.
2. Highlight **Current Position**, and press **ENTER** to open the Find Near Current Position Page.

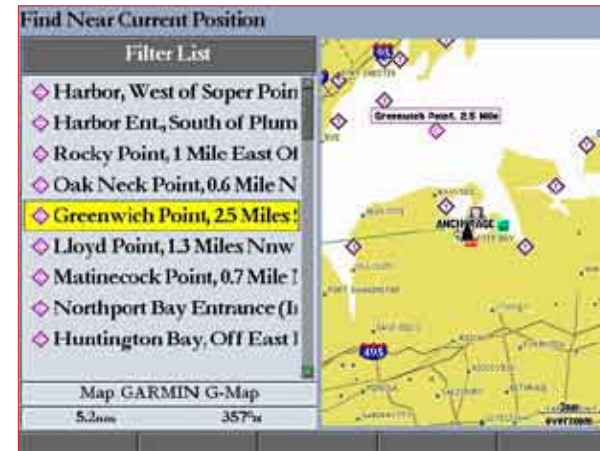

3. Select a Current Station from the list, and press **ENTER**. As you move the highlight over each Current Station in the list, the station is highlighted on the map window. The distance and bearing from your location to the highlighted station are shown at the bottom of the list.



**To select a Current Station from a map location:**

1. Highlight the **For** field, and press **ENTER** to open the Find Currents Page.
2. Highlight **Map Position**, and press **ENTER** to open the Find Near Current Position Page.
3. Press up or down on the **ROCKER** to move the map pointer to a map location, and press **ENTER**. The Find Near Other Position Page shows a list of Current Stations near the selected map location.
4. Select a Current Station, and press **ENTER**. If the “None Found” message appears, repeat steps 1–3 until you find a Current Station.

**Viewing a Current Report**

Press the **Show Report** soft key on the Current sub tab to view a detailed report of all times and values for all the minimum and maximum current flows throughout the day, including Flood, Slack, and Max Ebb times and strengths.



**Celestial Tab**

The Celestial tab shows celestial data for sun and moon rise and set, moon phase, and the approximate sky view location of the sun and moon. The moon phase shows the current visible portion of the moon as a light color. You can show this data for your current location, a location from the map, or a Find item location. Also, you can select a different date and time, or use the current date and time. The timetables shown are based on your current time zone.

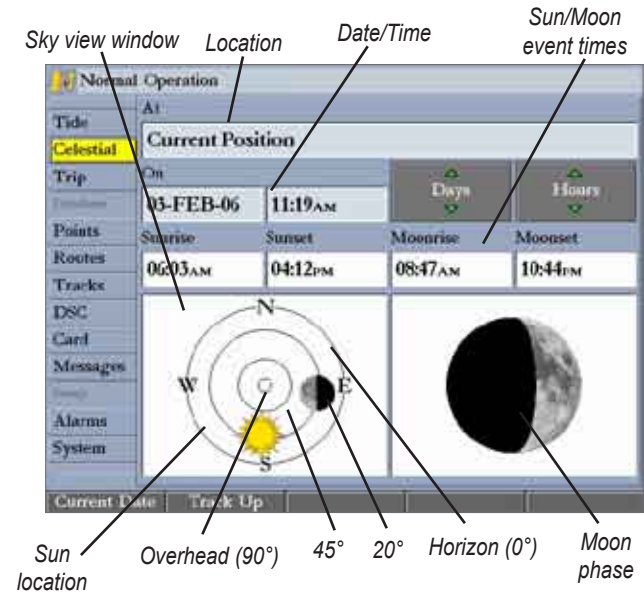

The Celestial tab contains the following soft keys:

- **North Up/Track Up**—fixes the sky view display to a north heading or to the current track heading.
- **Current Date**—press to show celestial information for today’s date.

**To view celestial information for a different location:**

1. On the **Celestial** tab, highlight the **At** field, and press **ENTER**. The Find Celestial Information Page appears.



2. Make a selection and press **ENTER** repeatedly until the information for that location appears on the **Celestial** tab.

**To change the time or date:**

1. On the **Celestial** tab, use the **ROCKER** to highlight the **Days** or **Hours** button, and press **ENTER**. Press up or down on the **ROCKER** to change the days or hours. Press **QUIT** to exit.  
OR  
Highlight the **On** field, and press **ENTER**.
2. Enter a new date or time, and press **ENTER**.
3. To return to the current date and time, press the **Current Date** soft key.

**Trip Tab**

The Trip tab shows data for Trip Odometer, Moving Average speed, Total Average speed, Maximum Speed, Stopped Time, Moving Time, Total Time, and Odometer.

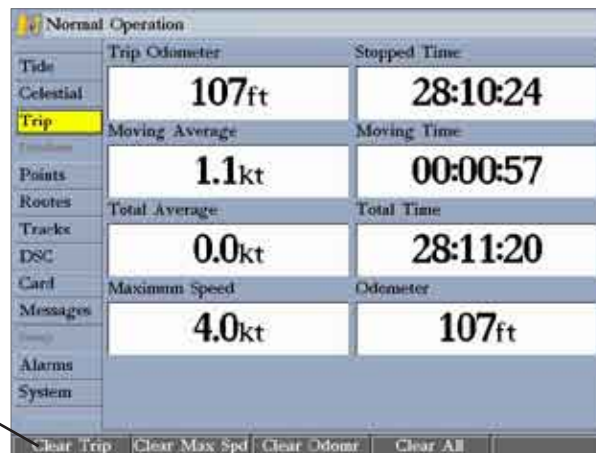

**Trip Tab**

The Trip tab contains the following soft keys:

- **Clear Trip**—clears all trip data.
- **Clear Max Spd**—resets the value in the Maximum Speed field to **0.00**.
- **Clear Odometer**—resets the value in the Odometer field to **0.00**.
- **Clear All**—resets the values in all fields.

# Weather Tab

The Weather tab shows current weather conditions, the forecast, sea surface information, and a forecast map. The Weather tab also contains a Setup sub tab that you can use to customize preset weather options.

The Weather tab appears only if you have the **Weather** check box selected on the System tab. See the “XM WX Weather” section beginning on [page 86](#) for more information.



**NOTE:** You **must** have a GDL30/GDL 30A Marine Weather/Audio Satellite Receiver installed and connected to your GPSMAP 3006C/3010C, and a subscription to XM WX Satellite Weather to use the XM Weather features.

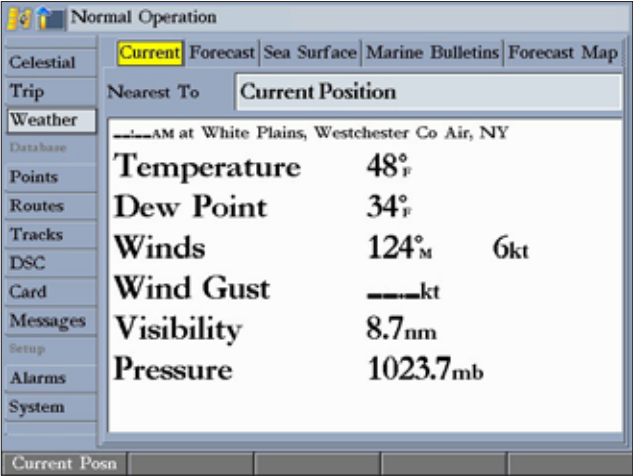

# Points Tab

The Points tab contains two sub tabs, User and Proximity, which allow you to manage a large number of waypoints quickly and efficiently. The sub tabs also provide continuously updated proximity waypoint alarms that can be used to define items, such as submerged hazards or shallow waters.



Number of waypoints remaining

Number of used waypoints

## User Sub Tab

The User sub tab on the Points tab displays a master list of all waypoints currently stored in memory. From the User list, you can review, edit, rename, or delete individual waypoints, or delete all user waypoints. The total number of stored and available waypoints appears at the bottom of the User sub tab, with the stored waypoints arranged in alphanumeric order.



### Proximity Sub Tab

Use the Proximity sub tab on the Points tab to define an alarm circle around a stored waypoint. The alarm circle can help you avoid reefs, rocks, or restricted waters. You can add proximity alarms to up to 10 waypoints, with a maximum alarm radius of 99.99 nautical or statute miles or kilometers.

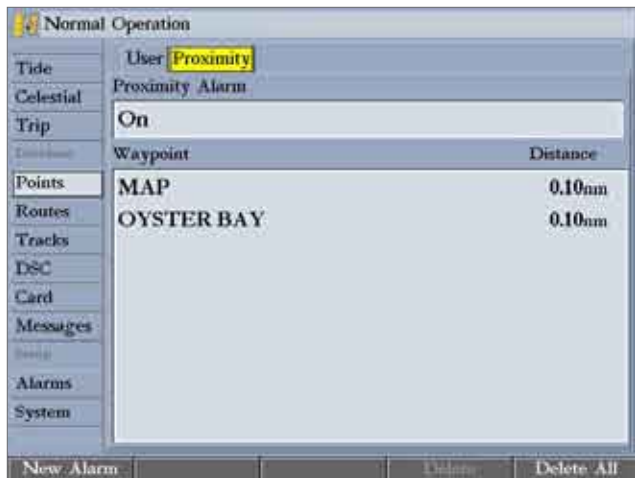

### Routes Tab

The Routes tab contains a list of available routes. See the “Creating and Using Routes” section beginning on [page 25](#) for more information about creating routes.

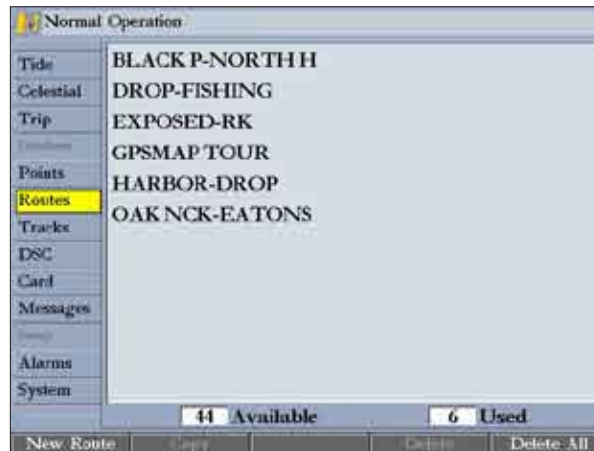

## Tracks Tab

Use the Tracks tab to specify whether or not to record a track log, define how it is recorded, or save track log data for future use. The Tracks tab also provides an indicator of the memory used for the active track log and allows you to clear the track memory. The Track tab is divided in two sub tabs: Active and Saved.

For more information setting up track options and saved tracks, see [pages 23–24](#).

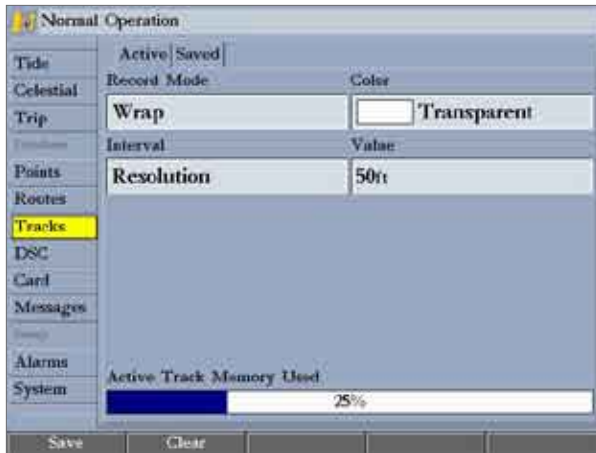

### Active Sub Tab

The **Active** sub tab shows the amount of track memory used and current settings for the active log (the log currently being recorded). The active log stores up to approximately 10,000 track log points, based on the criteria specified in the Track settings.

The following settings are available:

- **Record Mode**—allows you to select one of three track recording options:
  - **Off**—No track log is recorded. If you select **Off**, you cannot use the TracBack feature.
  - **Fill**—a track log is recorded until the track memory is full.
  - **Wrap**—a track log is continuously recorded, wrapping through the available memory (replacing the oldest track data with new data).
- **Color**—allows you to specify a color used to show the active track log on the Map and 3D Highway Pages.
- **Interval**—defines the frequency at which the track plot is recorded. Three interval settings are available:
  - **Distance**—records the track based on a user-defined distance between points.
  - **Time**—records track plot based on a user-defined time interval.
  - **Resolution**—records the track plot based on a user-defined variance from your course over ground or changes in water depth/temp (if equipped). The Resolution option is the default setting and is recommended for the most efficient use of memory and TracBack performance. The distance value (entered in the value field) is the maximum error allowed from the true course before recording a track point.
- **Value**—defines the distance or time used to record the track log.

The following soft keys are available:

- **Save**—saves the current active track log.
- **Clear**—clears the active track log currently stored in memory.

## Saved Sub Tab

The **Saved** sub tab shows a list of all saved track logs. It also allows you to use a track for TracBack or display it on a map. You can save up to 15 track logs in memory with up to 700 track log points in each saved log.

On the Saved sub tab, the following soft keys are available:

- **Review Map**—opens the Saved Track window so you can review the selected track.
- **Delete**—deletes the highlighted saved track log from memory.
- **Delete All**—deletes all saved track logs from memory.



## DSC (Digital Selective Calling) Tab

Use the DSC tab to control and set up DSC features on the GPSMAP 3006C/3010C. DSC uses marine VHF radio and GPS technologies to transmit and receive location information. DSC is used by mariners for two major operations—distress calls and position reporting.

For more information about DSC and Maritime Mobile Service Identity (MMSI) numbers, see [page 105](#) in the “Appendix.”

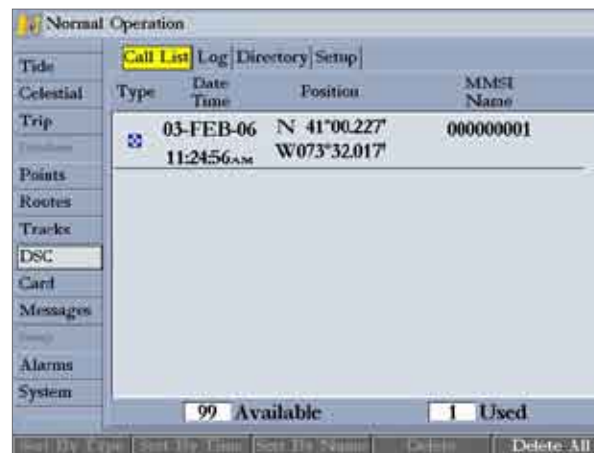

When the GPSMAP 3006C/3010C is connected to a VHF radio with DSC support, the GPS unit displays a call list, log, and a directory that stores incoming information received from another user’s DSC-capable VHF/GPS combination. Basic wiring is required for the Garmin unit and VHF radio to send and receive NMEA data from each other. See the *GPSMAP 3006C/3010C & GPS 17 Installation Instructions* for more information.

## Understanding DSC Distress Calls

With your GPSMAP 3006C/3010C properly connected to a VHF radio with DSC output, you can receive any DSC distress call within range. An alert message appears, and an alarm sounds (if enabled) when a distress call is received. The alarm sounds only for a distress call; position reports do not sound an alarm. Distress calls are broadcast to all DSC users in radio range and appear with a blue and white checkered icon on the DSC tab's Call List and Log sub tabs.

You can enter a caller's name, if it is known. The caller's name replaces the MMSI number as a reference, when entered.

## Understanding Position Reports

The position report operates similarly to the distress call. This type of contact is like a phone call; no emergency alarms are set off, and the call is specific to the receiver. Position reports are not broadcast to all DSC users and appear with a gold boat icon.

## Call List Sub Tab

The Call List sub tab shows the 100 most recent calls, even if the unit is left unattended. You can select any entry from the Call List to show an Entry Review.

## Log Sub Tab

When DSC calls are received, they are automatically stored in the log, with the latest call at the top. The unit can store up to 100 calls; after 100 calls are received, the oldest is removed when a new call is received.

The Call List and Log sub tabs both show the call type, date/time, position, and MMSI/Name. Pressing the Sort By (Call) Type, Sort By Time, Sort By Name, Delete (only after highlighting a particular call), and Delete All soft keys allows you to sort and delete calls.

## To review a call or log entry:

1. From the **DSC** tab, highlight the **Call List** or **Log** sub tab.
2. Press up or down on the **ROCKER** to highlight the call you want to review.
3. Press **ENTER**.

## Review DSC Waypoint

The Review DSC Waypoint Page operates similarly to the Distress Page and Position Report Page. From this page you can delete the displayed call. On the DSC Review Waypoint Page, press the **Delete** soft key to delete the entry, or press the **Create Wpt** soft key to create a waypoint.



Review DSC Waypoint

## DSC Directory

The DSC Directory acts like a phone book and can save up to 100 contacts. The directory lists all contacts by name and MMSI number. Press **ADJ** from this page to delete a highlighted entry or delete all entries.

### To add a new directory item:

1. Press the **New Item** soft key. The Directory Item Review window allows you to enter information of a known contact.
2. Highlight the **MMSI**, **Name**, or **Comment** field, and press **ENTER**.
3. Press up or down on the **ROCKER** to enter information, and press **ENTER**.

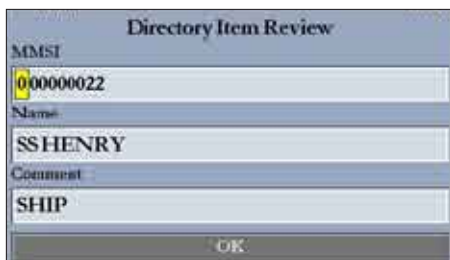

4. Press the **OK** soft key to save the entry.

After creating a New Directory Item entry, the name created is attached to that particular MMSI number. If you return to the log, the new name appears under the corresponding MMSI number.

Another way to enter a name is from the Entry Review Page or the DSC Distress Call or DSC Position Report Pages. The Name field is only available in the GPS tab. Names cannot be sent like the MMSI numbers to other DSC users.

## Setting Up DSC

Use the DSC Setup sub tab to turn DSC on and off. If you have more than one chartplotter and you only want DSC to show on one chartplotter, turn off DSC on all units but one.

You can use the **Setup** sub tab to simulate distress calls or position reports on this page while the unit is in Simulator Mode ([page 8](#)). Press either the **Sim Dstrs Call** or **Sim Posn Rpt** soft key to simulate a distress call or a position report. This is helpful practice before connecting to the real system. The Distress Call simulator also helps to determine if alarms are working properly.

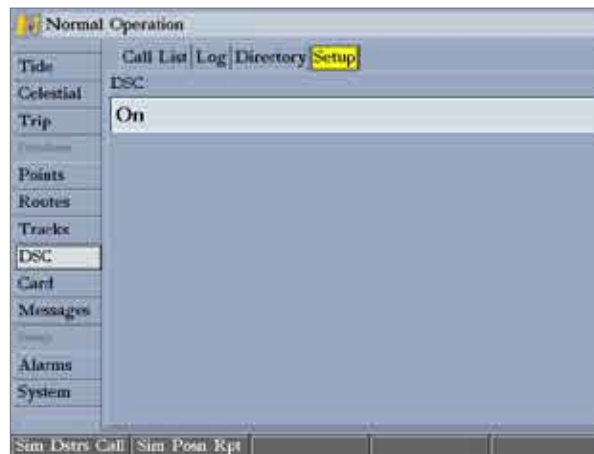

DSC Setup (Simulator Mode Shown)

## Using the NAV Key

If you receive a distress call or position report, you can quickly navigate to the caller using the NAV key. When the call is logged, press **NAV**, and select **Go To <MMSI number>** or **Go To <Name>**.



## Card Tab

Use the Card tab to transfer waypoints, routes, and tracks to and from a data card. When data is saved to a data card, it can be exchanged with other compatible units or transferred Garmin's MapSource software program on your computer.

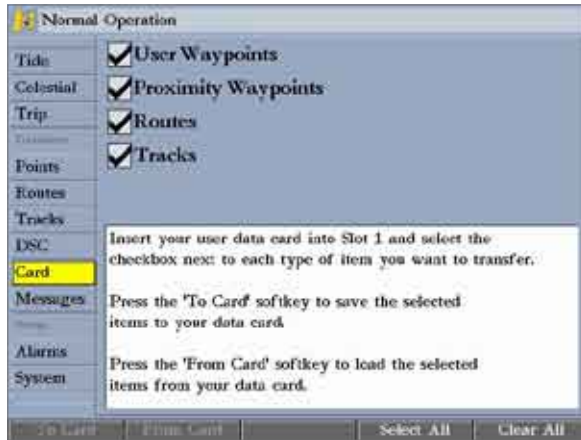

### To transfer data to or from a data card:

1. Insert the data card. If there is already user data on the card, highlight **Manage User Card**, and press **ENTER**. The Main Menu appears with the Card tab selected.
2. Select the check box next to each type of item you want to transfer (user waypoints, proximity waypoints, routes, or tracks).
3. Press the **To Card** soft key to save the selected items to the data card.
4. If transferring data from the card to the GPSMAP 3006C/3010C, press the **Merge From Card** soft key to combine the selected items with existing GPS data.  
OR  
Highlight **Replace From Card**, and press **ENTER** to overwrite all selected items on your GPS.
5. A "Transfer Complete" message appears in the status bar after the data is transferred. Press **QUIT**.

## Messages Tab

The Messages tab shows a list of messages generated by the GPSMAP 3006C/3010C. Use the **ROCKER** to scroll through the messages. The date and time when each message occurred is shown at the bottom of the tab.



### Viewing Detailed Message Information

You can view detailed information about the message, such as date, time, position, speed, course, and heading.

#### To view detailed information:

Highlight a message, and press **ENTER**. A window opens, showing detailed information for the selected message.

## Alarms Tab

Use the Alarms tab to define alarm settings. The Alarms tab is divided into four sub tabs: System, Nav, and Sonar. If you have a GDL 30/30A Marine Weather Satellite Receiver connected, the Weather sub tab is visible.

Alarm messages appear in red across the status bar or change the appearance of a data field if that field shows alarm-related data (for example, depth or voltage). Press **QUIT** to acknowledge an alarm message. The status bar and data field remain red while the alarm condition persists.

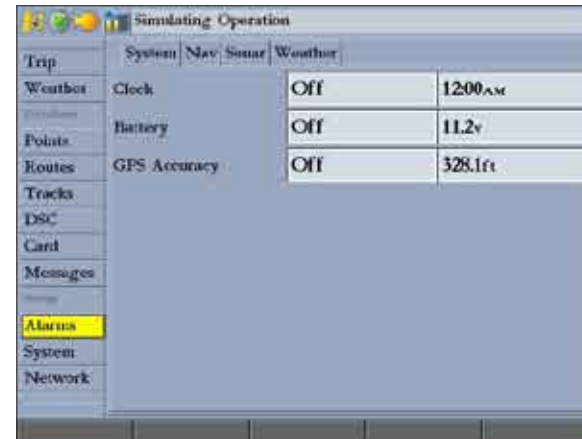

#### To set an alarm:

1. Use the **ROCKER** to highlight the **System, Nav, Sonar, or Weather** sub tab.
2. Highlight the field next to the alarm you want to set, and press **ENTER**.
3. Change the mode to the setting you want, and press **ENTER**.
4. Repeat steps 1–3 to set additional alarms, and then press **ENTER** when finished.

## System Alarms

Use the System sub tab to set alarms for the system clock, batteries, and GPS accuracy.

System	Nav	Sonar	Weather
Clock	Off		12:00 AM
Battery	Off		11.2v
GPS Accuracy	Off		328.1ft

The System sub tab contains the following alarms:

- **Clock**—provides an alarm for the system clock. Enter a time in the time field and turn the alarm on and off from the control field menu. Remember to enter alarm times in the same time format (UTC or local) you are using for your system. The unit must be on for the clock alarm to work.
- **Battery**—sets an alarm to sound when the battery reaches a user-determined low voltage.
- **GPS Accuracy**—sets an alarm to sound when the GPS location accuracy falls outside the user-determined value.

## Nav (Navigation) Alarms

Use the Nav sub tab to set navigational Alarms, including Anchor Drag, Arrival, and Off Course.

System	Nav	Sonar	Weather
Anchor Drag	Off		0.0ft
Arrival	Time		00:00:15
Off Course	Off		0.00km

- **Anchor Drag**—sets an alarm to sound when a specified drift distance is exceeded. Enter a value in the distance field, and use the control field to turn the alarm on and off.
- **Arrival**—sets an alarm to sound when a specified distance or time away from a destination waypoint is exceeded. Enter a distance, radius, or time for sounding the alarm, and use the control field to set the alarm to **Off**, **Dist** (distance), or **Time**.
- **Off Course**—sets an alarm to sound when you are off course by a specific distance. Enter a distance in the distance field, and use the control field to turn the alarm on and off.

## Sonar Alarms

Use the Sonar sub tab to set sonar alarms, including shallow or deep water, water temperature, and fish.\*

System	Nav	Sonar	Weather
Shallow Water	Off	20.0ft	
Deep Water	Off	100.0ft	
Water Temperature	Off		
Fish	Off		

- **Shallow Water/Deep Water**—sets an alarm to sound when you enter an area of specified depth that is too shallow or too deep. You must be receiving sonar data for this function to work.
- **Water Temperature**—sets an alarm to sound when the transducer reports a temperature either above, below, inside, or outside the specified values.
- **Fish**—sets an alarm to sound when the unit detects a fish of the specified symbols.

\*You must be receiving NMEA sonar data or using a GSD 20, GSD 21, or GSD 22 for the sonar alarms to function.

## Weather Alarms

Use the Weather sub tab to set Weather Alarms, Including Marine, Tornado, Severe Storm, Flood, and Flash Flood Warnings.\*\*

System	Nav	Sonar	Weather
Marine Warning	On		

\*\*You must have a GDL 30/30A Satellite Weather Receiver connected to your GPSMAP 3006/3010 for weather alarms to function.

## System Tab

The **System** tab consists of five sub tabs: General, Units, Time, Comm, and Update.



### General Sub Tab

Use the **General** sub tab to control system settings for System Mode, Speed Filter, Automatic Backlight, Beeper, Language, Simulator Controls, Restore Factory Default Settings, and to view the software version.

The following settings and options are available:

- **System Mode**—select **Normal** (normal navigation) or **Simulator** (for practice only). For more information about Simulator Mode, see “Simulator Mode” on [page 8](#).
- **Speed Filter**—averages speed readings. Select **Off**, **Auto** (automatically controls filtering), or **On** (allows you to enter a value from **1 to 255** seconds).

- **Automatic Backlight**—automatically adjusts the display brightness to a specified level at sunrise and sunset. You can specify offset minutes for before sunrise and after sunset.
- **Beeper**—controls the audible beep. Select **Off**, **Alarms Only** (sounds for alarms/messages), or **Key and Alarm** (sounds for key presses and alarms/messages).
- **Language**—sets the language for the unit’s on-screen text.
- **Services**—after a new device is detected on the network, clearing the **Auto-Detect Services** check box speeds up the startup sequence. If the **Auto-Detect Services** check box is not selected and new hardware is added, you must select the corresponding service check box to enable the new hardware device.

The following soft keys are available:

- **System Info**—shows the unit’s software, basemap version, and electronic serial number.
- **Update Notes**—shows software notes for the current software version.
- **Factory Defaults**—restores all settings to Garmin’s original setup values for all devices on the network.

### To adjust the automatic backlight settings:

1. Highlight the **Automatic Backlight** field, and press **ENTER**.
2. Using the **ROCKER**, highlight **On**, and press **ENTER**.
3. Highlight the **Setup** button, and press **ENTER** to open the Adjust Backlight window.
4. To adjust the backlight levels **For Day** and **For Night**, highlight the corresponding slider, and press **ENTER**.

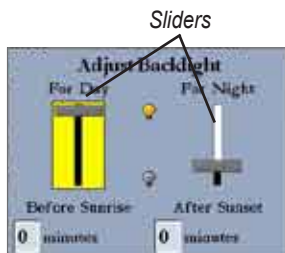

5. Press up or down on the **ROCKER** to increase or decrease the backlight level, and press **ENTER**.
6. To adjust the offset minutes, select the **minutes** field, and press **ENTER**.
7. Enter the offset minutes for **Before Sunrise** or **After Sunset**. If zero, the unit automatically changes to the specified level at sunrise/sunset. Press **QUIT** to exit.

## Units Sub Tab

Use the Units sub tab to define settings for Position Format, Depth, Map Datum, Temperature, Distance, Speed, and Elevation, Pressure, and Heading.



**WARNING:** The Units sub tab settings affect how navigation information appears on the GPSMAP 3006C/3010C. If you are using a map or chart with your GPS, make sure the settings on the Units sub tab match that of the map or chart. This information should be shown somewhere on the map or chart. If not, contact the map or chart maker to determine what position format, datum, heading, and units of measure are used for the map or chart.



The following settings are available:

- **Position Format**—used to change the coordinate system in which a given location reading appears. Only change the position format if you are using a map or chart that specifies a different position format or you want to use a format you are familiar with. The default format is latitude and longitude in degrees, minutes, and thousandths of a minute (hddd°mm.mmm').
- **Depth**—select the units of measure for depth in Feet (ft), Fathoms (fa), or Meters (m). You must be receiving NMEA Sonar depth data or using a Garmin Sonar Module for the depth to appear.

- **Map Datum**—manually select the datum reference used to determine a given location. The default setting is **WGS 84**. The unit automatically selects the best datum depending on your chosen position format. Datums are used to describe geographic locations for surveying, mapping, and navigation and are not actual maps built in the unit. Although more than 100 datums are available, you should change the datum only if you are using a map or chart that specifies a different datum.



**WARNING:** Selecting the wrong map datum can result in substantial position errors. When in doubt, use the default WGS 84 datum for best overall performance.

- **Temperature**—set the units of measure for temperature in Fahrenheit (°F) or Celsius (°C). You must be receiving NMEA Sonar temperature data or using a Garmin Sonar Module for the temperature to appear.
- **Distance, Speed, and Elevation**—set the units of measure for distance, speed and elevation readouts in Nautical (nm, kt, ft), Nautical (nm, kt, m), Statute (mi, mh, ft), or Metric (km, kh, m) terms.
- **Pressure**—set the units of measure you want to use for weather readouts in Inches Mercury (in), Millibars (mb), or Hectopascals (hPa). You must be using a Garmin weather product for this data to appear.
- **Heading**—set the reference used in calculating heading information. You can select **Auto Mag Var**, **True**, **Grid**, and **User Mag Var**. Auto Mag Var provides magnetic north heading references that are automatically determined from your present location. True provides headings based on a true north reference. Grid provides headings based on a grid north reference. User Mag Var allows you to specify the magnetic variation at

your present location and provides magnetic north heading references based on the variation you enter.



**WARNING:** If you select **User Mag Var**, you must periodically update the magnetic variation as your location changes. When using this setting, the GPSMAP 3006C/3010C unit does not automatically calculate and update the magnetic variation at your present location. Failure to update this setting can result in substantial differences between the information displayed on your unit and external references, such as a magnetic compass.

### To enter a user-defined magnetic variation:

1. With the **Heading** field set to **User Mag Var**, highlight the heading reference field (immediately to the right), and press **ENTER**.
2. Enter the magnetic variation at your current location, and press **ENTER**.

### Time Sub Tab

Use the Time sub tab to adjust the time format, enter a time zone, and adjust for Daylight Saving Time to show the correct local time.

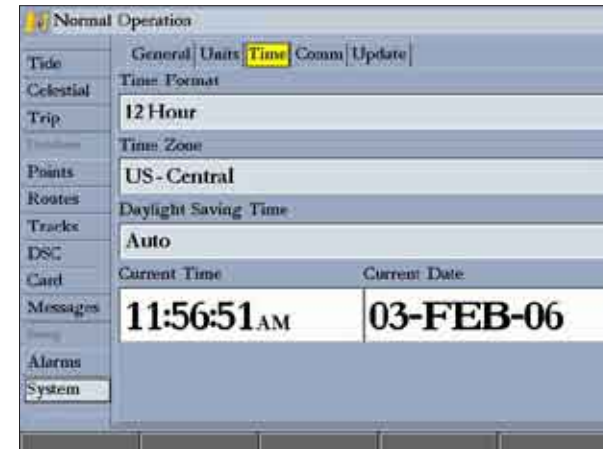

The following options are available:

- **Time Format**—select 12 Hour, 24 Hour (military), or UTC (also called Greenwich Time) time format.
- **Time Zone**—select your time zone to show correct local time or enter a UTC Offset (how many hours you are ahead or behind the time line).
- **Daylight Saving Time**—select **Auto**, **On**, or **Off** to adjust for Daylight Saving Time.

## Comm (Communications) Sub Tab

The Comm sub tab controls the input/output format used when connecting your GPSMAP 3006C/3010C to external NMEA devices or a personal computer. The unit supports two input/output ports.



**NOTE:** See the *GPSMAP 3006C/3010C & GPS17 Installation Instructions* for more information on wiring and NMEA information.

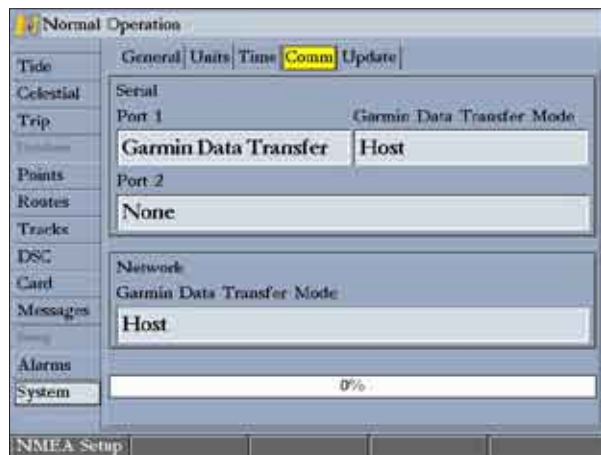

## Port 1

- **Garmin Data Transfer**—the proprietary format used to upload or download MapSource data, exchange waypoint, route, track, and proximity data with a computer or another Garmin unit. When you select **Garmin Data Transfer**, you can choose from nine Garmin Data Transfer Modes.
- **NMEA In/NMEA Out**—supports the input or output of standard NMEA 0183 data, DSC, and sonar NMEA input support for the DPT, MTW, and VHW sentences. You can also adjust the NMEA output.
- **NMEA High Speed**—supports the input or output of standard 0183 data for most AIS receivers.
- **None**—provides no interfacing capabilities.

## Port 2

- **NMEA In/NMEA Out**—supports the input or output of standard NMEA 0183 data, DSC, and sonar NMEA input support for the DPT, MTW, and VHW sentences. You can also adjust the NMEA output.
- **None**—provides no interfacing capabilities.

You can also adjust the NMEA output to enable or disable certain sentences and adjust the number of **Lat/Lon** output precision digits. You must have one of the ports set to **NMEA In/NMEA Out** to use this option. Settings affect both Port 1 and Port 2 NMEA outputs.

## Network

You can select the method to upload or download user data on networked chartplotters.

- **Merge User Data**—merges the user data for all chartplotters on each chartplotter.
- **Clone User Data**—the user data from the chartplotter initiating the clone replaces the user data on all other chartplotters attached to the network.



## NMEA Interface

If you are going to use the GPSMAP 3006C/3010C with a NMEA device (such as a VHF radio or autopilot), the unit needs to be set to input/output NMEA data. See the GPSMAP 3006C/3010C & *GPS 17 Installation Instructions* for information on wiring and NMEA data.

### To activate the NMEA data:

1. Highlight the **Port 1** or **Port 2** field, and press **ENTER**.
2. Highlight **NMEA In/NMEA Out**, and press **ENTER**.

When transferring data between two Garmin units, always set one to **Host** and use the other unit to send or request the data.

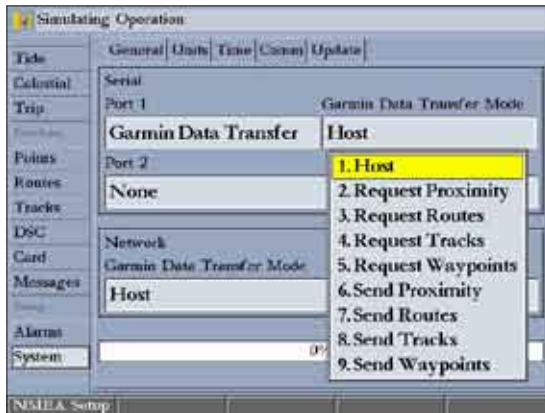

## Advanced NMEA Output Setup

The GPSMAP 3006C/3010C NMEA data transmission can be customized to change the precision of the **Lat/Lon** minutes, set up the waypoint IDs, and keep the output rate at two seconds. If the unit is set up to output all of the available NMEA sentences, the output rate may exceed two seconds.

Use the Advanced NMEA Setup Page to turn the GPS status (GSA, GSV), Waypoint/Route (WPL, RTE), and the Garmin proprietary sentences on or off. Check any other equipment's owners manual to see what sentences are required to be enabled for functionality.

**Lat/Lon Minutes Precision** allows you to adjust the number of digits to the right of the decimal point for transmission of NMEA Output, either 2, 3, or 4 digits. Use the **Waypoint ID** setting to output the waypoint identifiers as names or numbers.

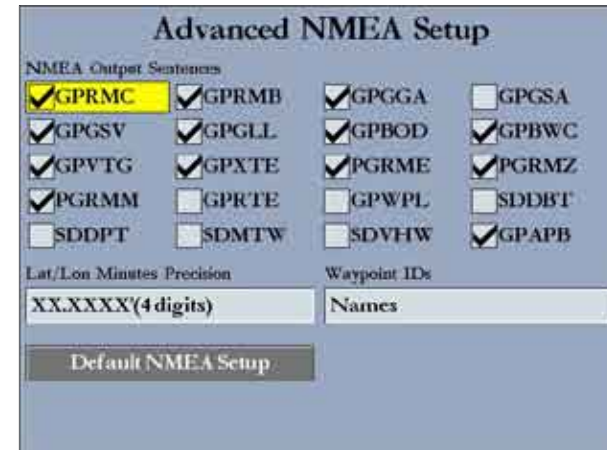

Advanced NMEA Setup Page

### To change the advanced NMEA settings:

1. Press the **NMEA Setup** soft key to open the Advanced NMEA Setup Page.
2. To change, enable, or disable NMEA output sentences, highlight the sentence, and press **ENTER** to select or clear the check box. Only selected sentences are output.

## Update Sub Tab

The Update sub tab shows the status of any software you are uploading to your unit.

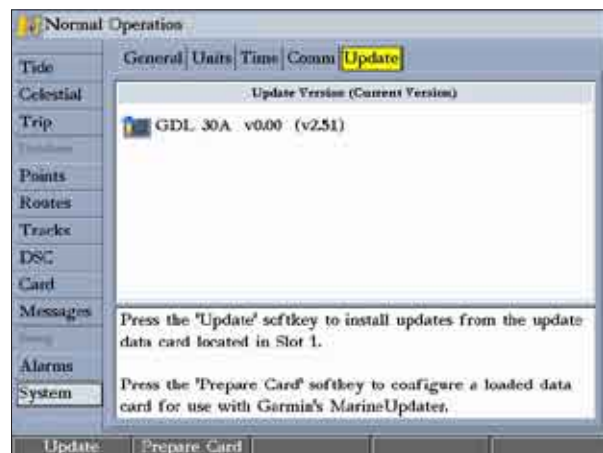

- **Update**—updates software on your unit.
- **Prepare Card**—updates software for devices on the Garmin Marine Network. When selected, information about your network installation is collected and saved to a data card. Use the data card with Marine Updater on your personal computer to download software updates for your system. Using Marine Updater, you can put all of the software updates on a data card. When you put the data card into the unit, it updates the software for all devices on the network. Check the Garmin Web site ([www.garmin.com](http://www.garmin.com)) for future updates and announcements.

## Network Tab

The Network tab shows all devices connected to your GPSMAP 3006C/3010C and the Garmin Marine Network, and the status of each. You can assign a name or identifier to each device on your network.

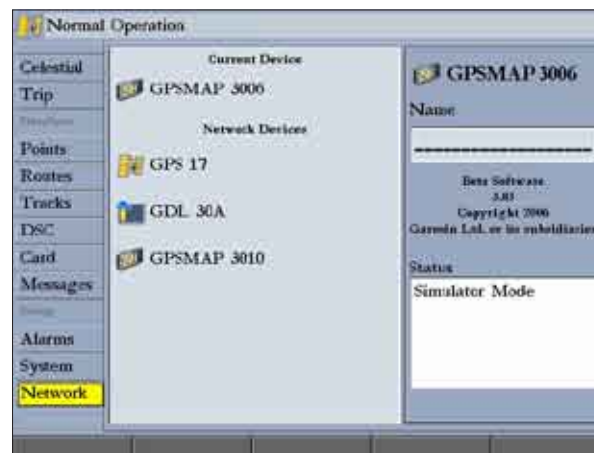

### To check the status of a device:

Use the **ROCKER** to highlight the device. The status of the network device is shown in the Status window.

### To assign a name to a device on the network

1. Use the **ROCKER** to highlight the device, and then press **ENTER** to highlight the **Name** field.
2. Use the **ROCKER** or data entry keys to enter a name for the device.
3. Press **ENTER** when finished.



**NOTE:** The GPSMAP 3006C/3010C connects to a GPSMAP 4000/5000 series but cannot share cartography.

## Pages Tab

Use the Pages tab to change the page sequence, or add or remove pages.

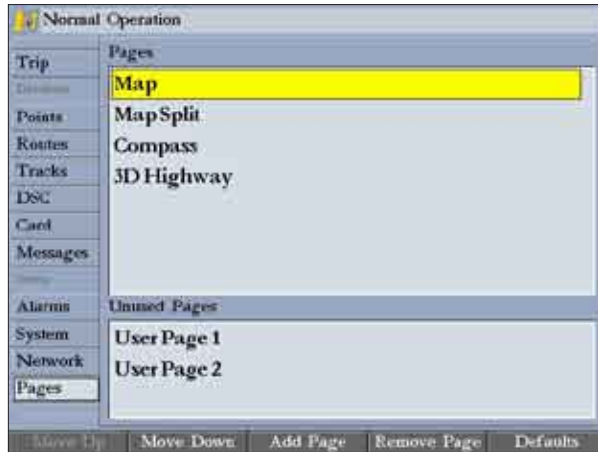

### To change the page sequence:

1. Use the **ROCKER** to highlight the page you want to move in the Pages list.
2. Press the **Move Up** soft key to move the page up, or press the **Move Down** soft key to move the page down in the list.
3. Repeat steps 1–2 to change the page sequence for additional pages.

### To add a page to the page sequence:

1. Press the **Add Page** soft key.
2. Highlight the page you want to add in the Unused Pages list, and press **ENTER**. The page is added to the Pages list and appears on the Pages Menu when you press the **ADJ** key. Press the **Move Up** or **Move Down** soft key to change page sequence.

### To remove a page from the page sequence:

1. Highlight the page in the Pages list.
2. Press the **Remove Page** soft key. The selected page is moved to the Unused Pages list.

### To restore page defaults:

Press the **Restore Defaults** soft key to restore the pages list to the default setting.

## Map Tab

Use the Map tab to change map settings, including map detail, map orientation, and automatic zoom. Changes made to the Map tab sub tabs affect all maps.

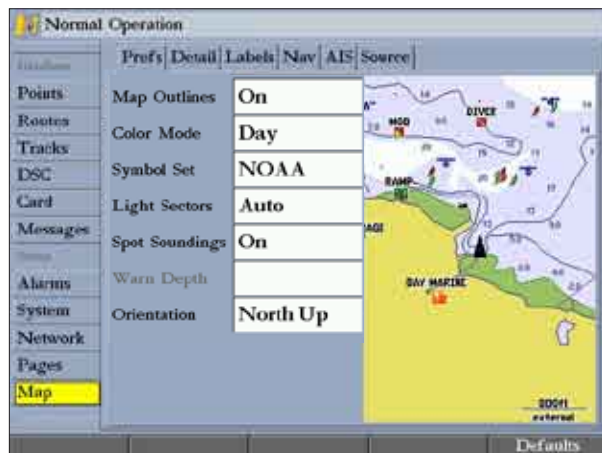

### To change a Map Setup feature:

1. On a Map function window, press the **Map Setup** soft key to open the Main Menu. The **Map** tab is highlighted.
2. Press left or right on the **ROCKER** to highlight a sub tab; press up or down on the **ROCKER** to highlight the setting you want to change, and press **ENTER**.
3. Press up or down on the **ROCKER** to select the setting you want, and press **ENTER**.
4. Press **QUIT** to exit.

The **Map** tab has six sub tabs—Prefs, Detail, Labels, Nav, AIS, and Source.

## Prefs Sub Tab

Use the Prefs sub tab to select map preferences.

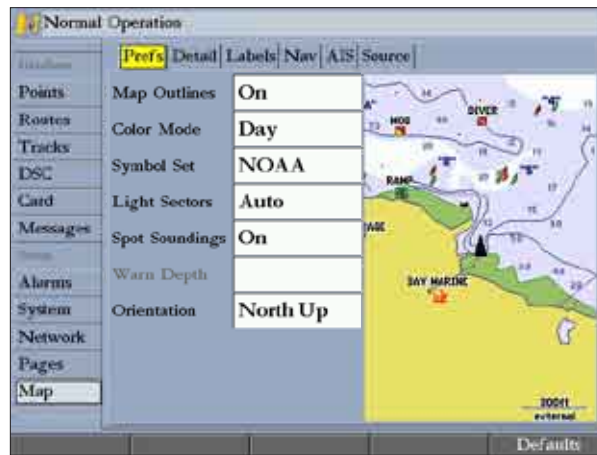

- **Map Outlines**—turns coverage boxes on or off for BlueChart/MapSource data.
- **Color Mode**—selections are Day or Night mode. Day mode shows more vibrant colors. BlueChart data can be used with either mode.
- **Symbol Set**—controls the navaid symbol set:
  - **NOAA**—all maps are drawn using a symbol set similar to NOAA/NIMA.
  - **International**—all maps are drawn using a symbol set similar to the IALA symbol set.
- **Light Sectors**—controls the drawing line sectors on the map. Select **Off**, **Auto**, or **On**.

- **Spot Soundings**—turns on the depth spot sounding data. Select **On**, **Warn Depth**, or **Off**.
- **Warn Depth**—shows the spot sounding below the set value in red. This field is available only when **Warn Depth** is selected in the Spot Soundings field.
- **Orientation**—sets the orientation of the map:
  - **North Up**—fixes the top of the map to a north heading.
  - **Track Up**—fixes the top of the map to the current track heading. Set to **All Ranges** for constant Track Up. The numeric value is the map zoom range at which the unit switches to North Up when zooming out.
  - **Course Up**—fixes the map so the direction of navigation is always up and turns the course line vertical on the screen.
- **Defaults**—restores map settings to factory defaults for all tabs. Press the **Defaults** soft key to restore original settings.

### Detail Sub Tab

Use the Detail sub tab to control the amount of detail for charts, Waypoints, Active Routes, Tide Stations, Services, Saved Tracks, and Track Logs shown on the Map Page.

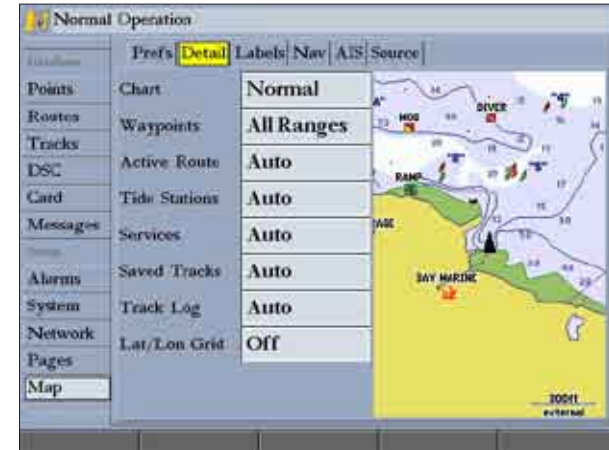

- **Chart**—controls how much map detail you see and which charts the unit chooses to use for a particular map zoom range. Select **Most**, **More**, **Normal**, **Less**, or **Least**.
- **Chart**, **Waypoints**, **Active Route**, **Tide Stations**, **Services**, **Lat/Lon Grid**—sets the maximum scale at which the feature should appear on-screen. Select **Off**, **All Ranges**, **Auto**, or **<30 ft to <800 nm**.



**NOTE:** Some types of data only show up to certain map zoom ranges.

## Labels Sub Tab

Use the Labels sub tab to select the screen size of the text for a given map item.

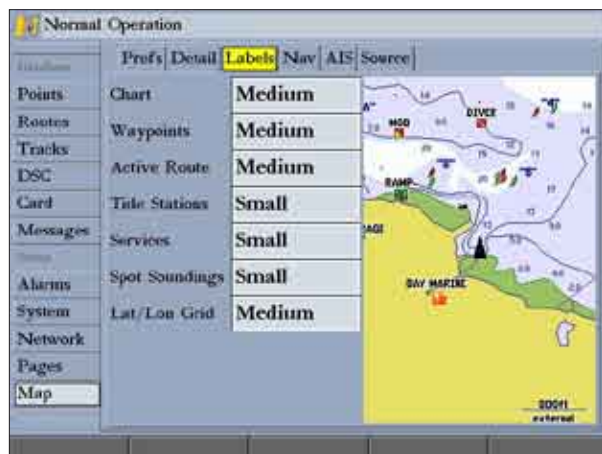

**Chart, Waypoints, Active Route, Tide Stations, Services, Spot Soundings, Lat/Lon Grid**—controls the screen size of the text for a given map item. Select **None, Small, Medium, or Large**.

## Nav Sub Tab

Use the Nav sub tab to show or hide certain navigational features on the Map Page and the scale at which they appear.

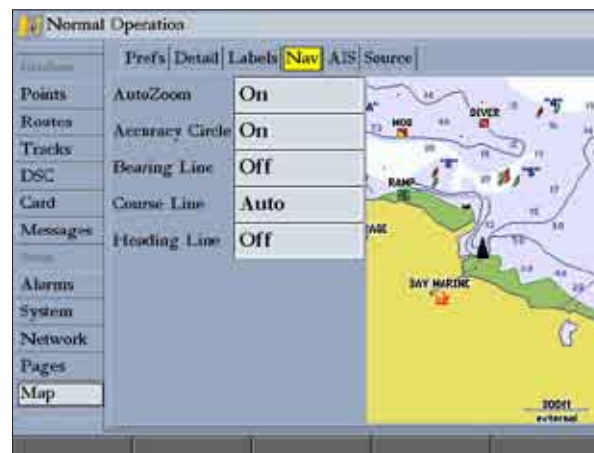

The Nav sub tab contains the following options:

- **AutoZoom**—toggles the automatic zoom on or off. When **On**, the map automatically adjusts the map to a lower range as you approach your destination point.
- **Accuracy Circle**—toggles the circle on or off. The circle represents the approximate accuracy of the GPS position based on EPE (Estimated Position Error) and map data quality. Your actual location is somewhere within the circle.
- **Bearing Line**—sets the maximum scale at which the feature appears on the screen and toggles the red/yellow line that continually points to the current navigation point. Select **Off, All Ranges, Auto, or <30 ft to <800 nm**.

- **Course Line**—sets the maximum map zoom range at which the course line appears on-screen. Select **Auto**, **Off**, or **<120 ft to <800 nm**.
- **Heading Line**—draws an extension from the end of the boat icon in the direction of travel. For **Distance**, enter the numeric distance value to which you want the line to extend. For **Time**, enter the numeric time value for which you want the line to extend. The Time line length automatically adjusts as your speed changes.

### AIS Sub Tab

AIS (Automatic Identification System) alerts you to area traffic. AIS provides ship IDs, position, course, and speed for ships equipped with a transponder within range.



**NOTE:** You must set your chartplotter communication to **NMEA In/NMEA Out** with a baud rate of 38,400 to receive AIS information.



The AIS sub tab contains the following options:

- **AIS Vessels**—sets the maximum max zoom range at which AIS vessels appear on-screen. Select **Off**, **Auto**, **All Ranges**, or **<30 ft to <800 nm**.
- **Heading Line**—draws an extension from the end of the boat icon in the direction of travel. For Time, enter the numeric time value for which you want the line to extend. The Time line length automatically adjusts as your speed changes.

### Source Sub Tab

Use the Source sub tab to turn basemaps and card maps on or off.



- **Basemap**—turns the built-in basemap on or off.
- **External Maps**—turns all optional BlueChart g2 or MapSource data on the data card on or off.

Use the **Advanced** soft key to show a list of the optional BlueChart or MapSource data loaded on the data card. Each map family (or type) is described by name and can be hidden if you do not want to show the data on the Map Page.

### To show the Advanced Map Card Setup:

1. Press the **Advanced** soft key to open the Advanced Map Card Setup window.
2. Use the **ROCKER** to highlight a map family in the Map Family Name list.
3. Press the **Off** soft key to select or hide the map family, or press the **On** soft key to show the map family. The map appears on the Map Page when a check mark appears in the box adjacent to the map.

OR

Press the **Show All** soft key to show all map families. Press the **Show None** soft key to clear all check boxes.

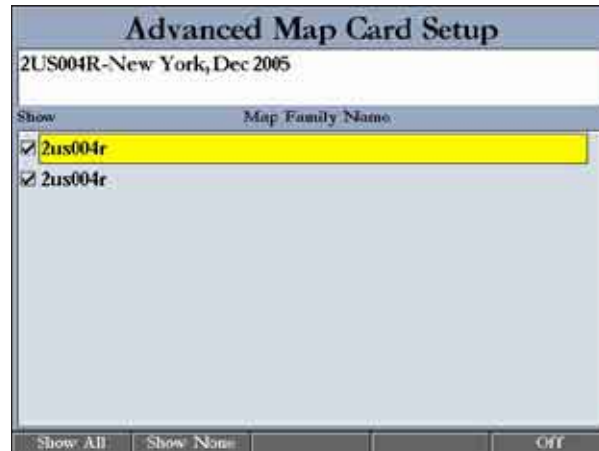

4. To view the notes or chart information for that map area, highlight the map name, and press **ENTER**.

5. Press the **Chart Info** soft key to view chart information. Press the **Notes** soft key to view chart notes.
6. To scroll through the notes, highlight the **Notes** fields, press **ENTER**, and use the **ROCKER** to scroll up, down, left, and right.
7. Press **QUIT** to exit.

## Radar Tab

The Radar tab contains setup options for the Radar Page. The Radar Page appears only if you have the **Radar** check box selected on the System tab. See the “Using Radar” section on [page 89](#) for more information.

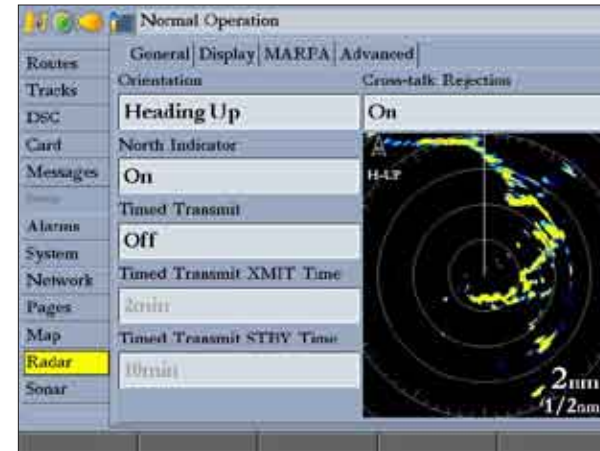



## Temp (Temperature) Tab

The Temp tab displays the water temperature log (if equipped with a temperature sensing transducer or receiving NMEA Sonar temperature data). The chart reads from right to left, so that the most recent temperature measured appears on the far right side of the chart. The dotted grid lines within the chart indicate intervals in the temperature scale and the duration of time.



- **Log and Graph Scale**—sets the temperature range (in degrees) for the log. Select **Auto** to have the unit automatically determine the best range, or select a span of 2, 4, 6, 8, or 10 degrees. Use the **Reset** button in Auto mode to reset the automatic range.
- **Log Duration**—sets how fast or slow the temperature log scrolls (the shorter the time duration, the faster the temperature log scrolls). Select a duration from 1 minute to 2.5 hours.

## Sonar Tab

The Sonar tab contains setup options for the Sonar Page. The Sonar Page appears only if you have the **Sonar** check box selected on the System tab. See the “Using Sonar” section on [page 76](#) for more information.

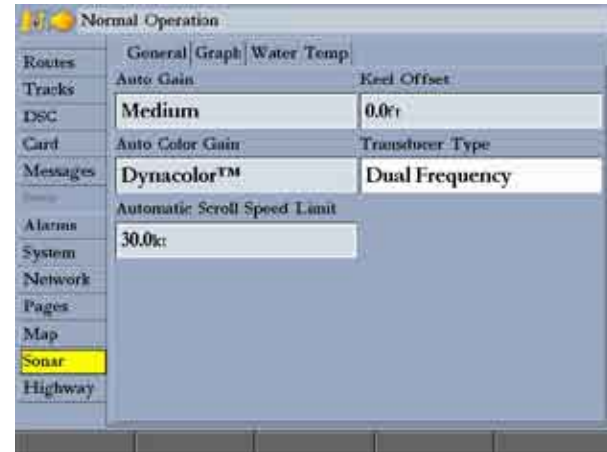

## Highway Tab

Use the **Highway** tab to select whether waypoints and tracks are shown on the 3D Highway Page. Use the **ROCKER** and the **ENTER** key to select or clear options.

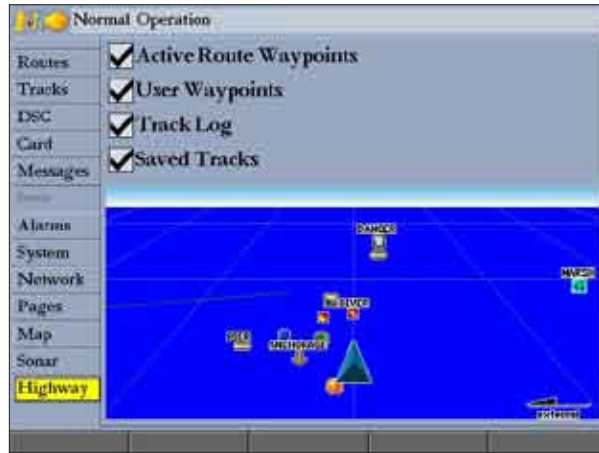

- **Active Route Waypoints**—show all active route waypoints.
- **User Waypoints**—show only nearby waypoints.
- **Track Log**—show current active track log.
- **Saved Tracks**—show any saved track logs.

## XM Tab

Use the XM tab to view and select XM Radio channels, add or delete favorites, and obtain radio ID and XM WX Weather service level information. The XM tab contains two sub tabs: Audio and Information. The XM tab appears only if the **Weather** or **XM Audio** check box is selected on the System tab and you have a GDL30/30A connected to your GPSMAP 3006C/3010C.



**NOTE:** You must have a GDL30A connected to your GPSMAP 3006C/3010C and your stereo receiver and a subscription to XM Radio to use the XM Radio feature. For more information, see the *GDL 30/30A Owner's Manual*.

## Audio Sub Tab

Use the Audio sub tab to view and select XM Radio channels, add a channel to or remove a channel from the Favorites category, scan channels, and turn audio output on or off. The Audio sub tab appears only if the **XM Audio** check box is selected on the Main Menu—System tab.

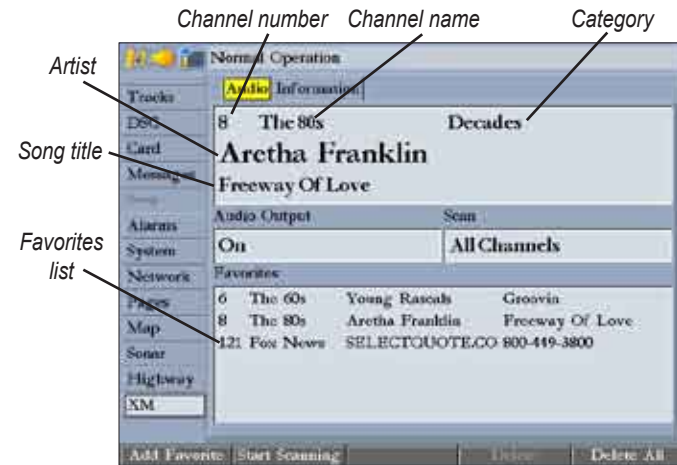

**To select an XM Radio channel:**

1. Highlight the song, and press **ENTER**.
2. Press up or down on the **ROCKER** to select a channel, and press **ENTER**.

**Using Favorites**

You can create a customized list of your favorite XM Radio channels.

**To add a channel to Favorites:**

Select a channel, and then press the **Add Favorite** soft key. The channel appears in the list of favorites.

**To delete a channel from Favorites:**

1. In the Favorites list, select a channel to delete, and then press the **Delete** soft key to delete the selected channel from your Favorites list, or press the **Delete All** soft key to delete all channels from your Favorites list. A confirmation message appears.
2. Highlight **OK**, and press **ENTER** again to confirm.

**To scan XM Radio channels:**

1. On the **Audio** sub tab, highlight the **Scan** field, and press **ENTER**.
2. Select **All channels** to scan all channels.  
OR  
Select **Category** to scan only channels in the selected category.  
OR  
Select **Favorites** to scan only channels in your Favorites list.
3. Press the **Start Scanning** soft key. Each channel plays for five seconds and then advances to the next channel.
4. Press **ENTER** to stop scanning.

**To turn audio on or off:**

1. On the **Audio** sub tab, highlight the **Audio Output** field, and press **ENTER**.
2. Highlight **Off** to turn off the audio output, or highlight **On** to resume audio output, and press **ENTER**.

**Information Sub Tab**

Use the Information sub tab to view the radio identification number for weather and audio, XM WX Weather subscription information, and a list of weather features available to you based on your subscription plan. The Audio sub tab appears.



## USING SONAR

This section covers the additional options for the GPSMAP 3006C/3010C when used with a GSD 20, GSD 21, or GSD 22 Sounder Module. Read the installation instructions included with your Garmin Sounder Module to install the it.



**NOTE:** You must have a GSD 20, GSD 21, or GSD 22 Sounder Module installed and connected to your GPSMAP 3006C/3010C to use the sonar features.

## Understanding Sonar

The transducer mounted on your vessel sends sound waves down into the water in a cone shape, similar to a flashlight beam (covering a smaller circular area at the top and angling out to a larger circular area at the bottom). These sound waves reflect off of any object that they hit, and then the waves travel back up to the transducer. These objects could be fish, branches, the bottom, or any other object that has a density that is different from the water. The transducer receives the sound wave information and then sends the information to the GSD 20, GSD 21, or GSD 22 sounder module and then to the GPSMAP 3006C/3010C. The GPSMAP 3006C/3010C displays the information on the screen for you to see and interpret. The type of transducer and the settings that you choose determine how the information is displayed on the screen.

### Using Dual Frequency

Dual frequency works best for deep water (off-shore) applications. The 200 kHz frequency allows you access to great detail about what is underneath your boat. The 50 kHz frequency provides less detailed information, but penetrates to greater depths with the same power. You can choose either or both frequencies to get the information that you want. If you choose dual frequency,

the transducer alternates between the 50 kHz and 200 kHz signals. This capability allows you to see the best picture available at any depth.

### Using Dual Beam

Dual beam works best for shallow water (for example, inland) applications. A dual beam transducer can transmit a narrow or a wide beam. The water area covered by the transmitted sound waves is determined by the beam width of the transducer and the water depth. The narrow beam provides crisp detail of what is under your boat, and is very helpful if you are fishing in deeper water where the beam covers more area (for example, at a 30-foot depth, the narrow beam covers the area of about a 7-foot circle).

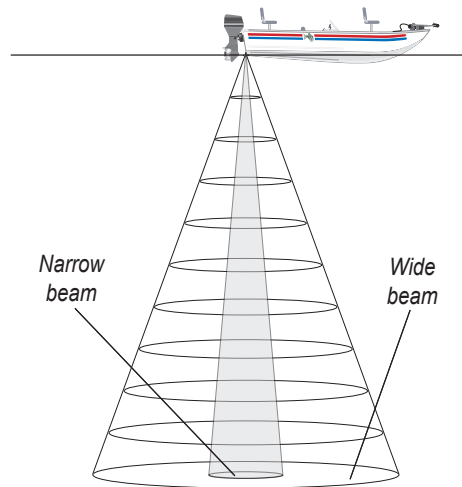

The wide beam is more helpful in shallow water, because it gives you a much wider view of objects in the water, including areas beyond the sides of your boat. At a 30-foot depth, the wide beam covers the area of approximately a 20-foot circle.

## Understanding the Sonar Display

One of the first things to understand about sonar is that the transducer sends a beam down to the bottom of the water, much like the beam of a flashlight. The beam starts small near your vessel and expands as it gets to the bottom.

The Sonar Page does not show a 3-D representation of the underwater environment. Instead, the display is in two dimensions, much like if you took a picture of an aquarium. Only the depth of the item in the water is shown.

The strongest sonar returns appear on your screen as the most intense solid color (depending on your selected color scheme; red is the default). The weakest returns appear as the less intense, less solid colors (blue is the default).

The bottom is always the strongest signal, and therefore the most intense color. The bottom is the continuous, intensely-colored line running across the bottom of the screen. The GPSMAP 3006C/3010C uses the latest technology in interpreting bottom signals; it can see through fish, structures, and thermoclines (shown in the weakest colors). However, large schools of fish or dense structures close to the bottom can affect water depth return readings.



**NOTE:** If the GPSMAP 3006C/3010C is unable to track the bottom for any reason, the digits in the depth window flash on and off to alert you that the unit is not tracking the bottom.

At the top of the screen, you might see a grouping of intense colors. This area is surface clutter, which can be caused by waves or any other sonar interference at the surface of the water. Too much surface clutter can obscure your view of fish. You can turn down the Gain setting to reduce this surface clutter.

Between the bottom and the surface clutter, the fish appear as arches. Actual fish returns might not always appear as perfect arches, due to the speed, fish orientation, or other conditions. You can turn on the Fish Symbols setting if you want to see on-screen fish in a fish shape.

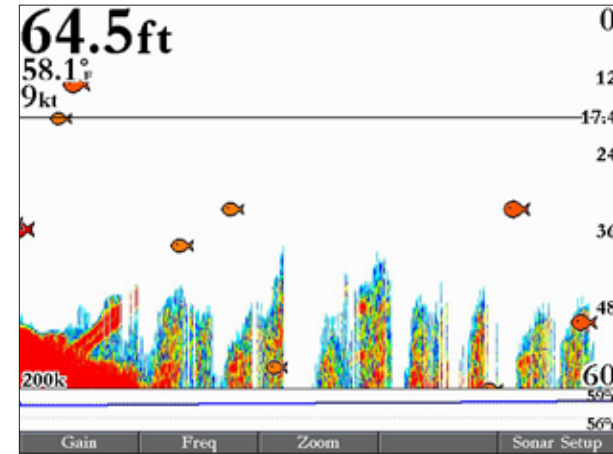

**Fish Symbols Turned On**

The strength of the sonar return can also help you interpret the hardness of the bottom (the thicker the bottom line, the harder the bottom).

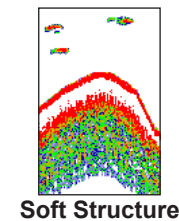
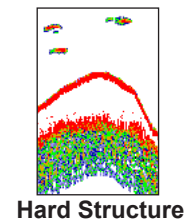

## Sonar Page

The Sonar Page is where your GPSMAP 3006C/3010C becomes a powerful fishfinder/flasher. If a GSD 20, GSD 21, or GSD 22 Sounder Module is not attached, the Sonar Page appears only when the GPSMAP 3006C/3010C is in Simulator Mode or if the **Sonar** check box is selected on the System tab.

### To view the Sonar Page:

Press **PAGE** repeatedly until the Sonar Page appears.

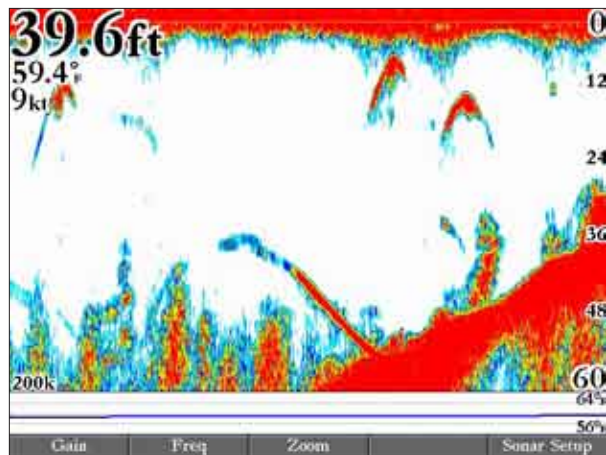

The sonar function window contains a right-to-left moving sonar image of the water beneath your boat. Items appear as they pass under the transducer. The most recent data is shown on the right side of the screen. The right side of the screen contains a scale reflecting the depth of the area being shown. The top-left corner shows the depth, water temperature, and speed through water (if equipped with a temperature or speed sensor).

Use the **Fish Symbols** option to view the actual sonar data, fish symbols, or a combination of both. Fish symbols appear as red.

You can set the sonar display to show a split screen view of a zoomed portion of the sonar, split frequencies, bottom lock (display scaled from the bottom up), or a combination of these options. For example, you can choose to show dual frequency at a 2X zoom (Dual 2X) on one half and normal range dual frequency (Dual) returns on the other half. The display mode appears at the bottom of each sonar display.

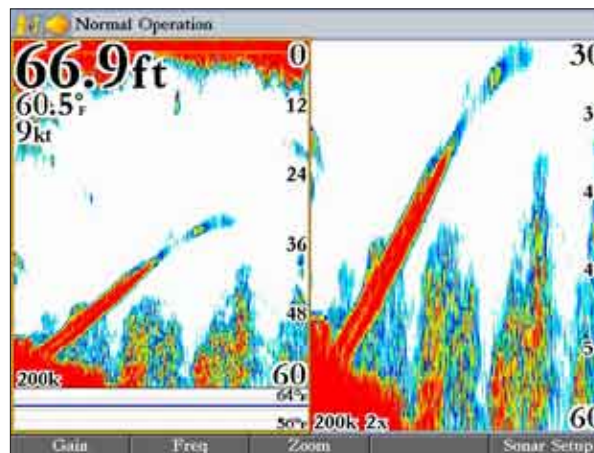

**Sonar Page with Split Screen**

## Configuring the Sonar Page

You can customize the Sonar page to fit your navigational needs See “Configuring Main Pages” on [page 33](#) for more information.

### To add or remove functions on the Sonar Page:

1. Open the Sonar Page, and then press and hold the **DATA/CNFG** key to open the Configuration window.



2. Using the **ROCKER**, highlight the function you want to add or remove, and press **ENTER**. Only functions with a check mark in the check box next to them appear on the Sonar Page.

### To split the screen:

1. On the Configuration window, press the **Split Zoom** soft key to show a split screen view of a zoomed portion of the sonar.  
OR  
Press the **Split Freq** soft key to show two different frequencies.
2. Press **QUIT** to return to the Sonar Page.

## Using the Flasher

If you prefer the appearance of flasher sonars, select the **Flasher** function on the Configuration window for the Sonar Page. It provides an almost instantaneous return of what is below your boat.

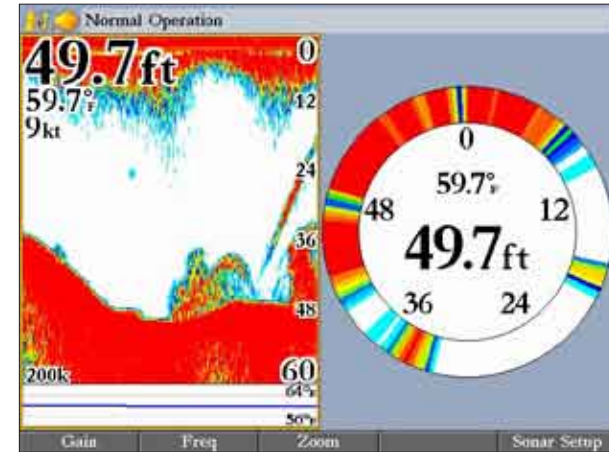

Sonar Page and Flasher

The most intense, constant signal on the Flasher is the actual depth and bottom. The colors indicate the different strength of the signals.

- A soft bottom (such as silt or mud) creates a signal that is narrow and more faint.
- A hard bottom (such as sand or rock) creates a signal that is wider.

## Using the Sonar Adjustment Menu

Use the Sonar adjustment menu to access the settings and features most commonly used on the Sonar Page.

### To select an adjustment option from the Sonar Page:

1. Press **ADJ** to open the Sonar adjustment menu.

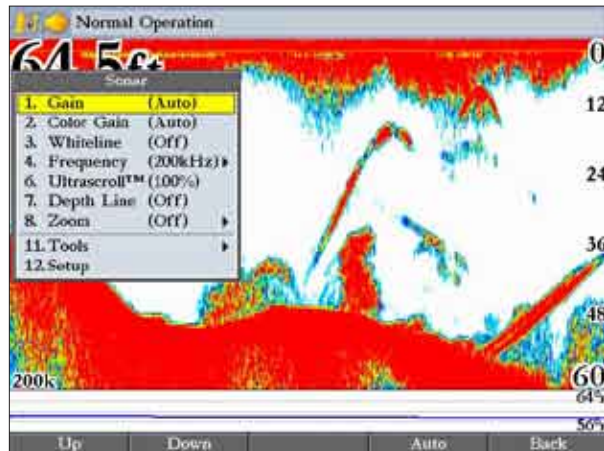

2. Press up or down on the **ROCKER** to highlight the option you want to change, and press **ENTER**.
3. Use the soft keys to make adjustments.
4. To exit any of the adjustment options, press the **Back** soft key, or press **QUIT**.

### To change a Sonar adjustment menu setting:

1. Select an adjustment menu option using the method described previously.
2. Press up or down on the **ROCKER** to change the setting, range, or percentage (Off, 1-100%).
3. Press **ENTER** to accept the change, or **QUIT** to close the Sonar adjustment menu.

The Sonar adjustment menu contains the following options:

- **Gain**—controls the sensitivity of the sonar receiver. **Auto** (default) is the recommended setting. It automatically sets the sonar sensitivity. You can also set the gain manually. To see more detail on the screen, increase the receiver sensitivity by selecting a higher gain. If there is too much detail or if the screen is cluttered, lower the sensitivity (lower the gain) to increase the clarity of the screen. If Frequency is set to **Dual**, you can set the Gain separately for each frequency (50 kHz and 200 kHz).
- **Color Gain**—controls what colors are applied to the objects on the screen. **Auto** (default) is the recommended setting. It automatically sets the colors, based on your Auto Color Gain setting. You can also set the Color Gain manually. If Frequency is set to **Dual**, you can set the Color Gain separately for each frequency (50 kHz and 200 kHz).
- **Whiteline**—controls how the unit shows information about the bottom type (hard or soft). With the Whiteline Off, the bottom return shows as red and contains no information on bottom hardness. With Whiteline set at Normal or 1-100%, the bottom return becomes white with a red line, in the default color scheme, indicating where the water meets the bottom. To turn the Whiteline Off, press the **ROCKER** down until the setting bar is all the way at the bottom of the range and reads “Off”.



- **Frequency**—only appears when using a dual frequency transducer. This allows you to choose a sonar operation frequency. You can choose **200 kHz**, **50 kHz** or **Dual** frequency (to alternate between the two frequencies).
- **Ultrascroll™/Scroll**—adjusts the rate at which the Sonar Pages scrolls from right to left. **Ultrascroll™** (default) is used when you select a scroll rate from 90% to 100%. **Auto** automatically adjusts the scroll rate according to the boat's speed.
- **Depth Line**—adds a horizontal depth line across the screen that is used to measure the depth of underwater objects. The depth of the line appears on the right side of the line. Press up or down on the **ROCKER** to control the position of the line on the Sonar Page. To turn the Depth Line off, press the **ROCKER** up until the setting bar is all the way at the top of the range and reads "Off".

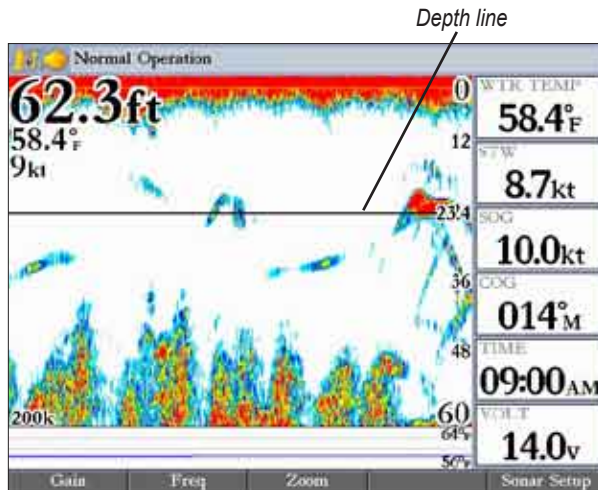

**Zoom**—sets a screen zoom scale. The following settings are available:

- **Off**—turns off the Zoom function.
  - **2x Zoom**—displays the 2x zoomed picture.
  - **4x Zoom**—displays the 4x zoomed picture.
  - **Btm (Bottom) Lock**—displays returns from the bottom up. When using this setting, “BL” appears at the bottom of the screen.
  - **Zoom View**—available when you select a Zoom scale other than **Off**. You can use the Zoom View setting to change the viewing range of a zoomed display. **Auto** follows the water bottom. If the display is set to **Bottom Lock**, the Span setting adjusts how far off the bottom the unit shows data.
  - **Tools**—controls the display of useful sonar tools. The following options are available:
    - **A-scope**—when you turn on A-scope, a vertical flasher bar appears on the far-right side of the screen. This flasher displays structure and bottom returns much the same as the Flasher Page. The horizontal width of the A-scope signal indicates the strength of the signal.
    - **Color Bar**—shows a gradient scale of the current Color Gain setting.
    - **Temp Graph**—appears only if you have a temperature-capable transducer. When on, this setting displays a temperature graph on the bottom of a Sonar Page that matches the scrolling data.
  - **Setup**—opens the Sonar tab.
- To adjust the range:**  
On the Sonar Page, press the up **RANGE** key to decrease the range, or press the down **RANGE** key to increase the range.

The unit can be set to automatically track the bottom (Auto) or set to a user-specified depth range.

## Using the Pointer on the Sonar Page

You can display the pointer (arrow) to reference sonar items and mark underwater waypoints. This makes it easier to find and use an object such as a stump as a future fishing location.

When using this feature, the Sonar Page pauses. The depth continues to update while the display is paused, but the unit does not show any new sonar data until the Sonar Page resumes scrolling. Discontinuity is possible from where the sonar information stops and where it starts again.

## Marking an Underwater Waypoint

You can mark waypoints that are under the surface of the water.

### To mark an underwater waypoint:

1. On the Sonar Page, use the **ROCKER** to move the pointer to the location you want.
2. Press and release **ENTER/MARK**. The Review Waypoint Page appears with the waypoint's coordinates, default name, and pointer depth automatically filled in.
3. To change the name, symbol, or depth, highlight the appropriate field, and press **ENTER**. Make any changes, and press **ENTER** when finished.
4. Highlight **OK**, and press **ENTER** to return to the Sonar Page.
5. Press **QUIT** to resume scrolling.

## Sonar Tab

When a Garmin Sounder Modul is connected to the GPSMAP 3006C/3010C, and either the **Auto-Detect Services** or **Sonar** check box is selected on the System tab, the Sonar tab appears on the Main Menu.

Use the Sonar tab to set up the Sonar Page. The Sonar tab has three sub tabs: General, Graph, and Water Temp.

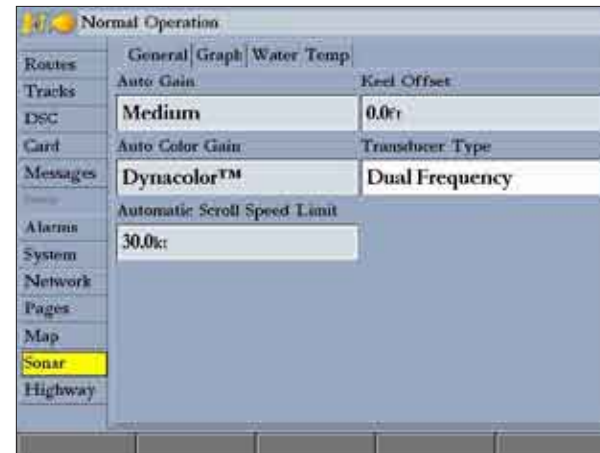

### To access and change a setting on the Sonar tab:

1. Press the **Sonar Setup** soft key to open the Main Menu. The Sonar tab is automatically selected.
2. Highlight the setting you want to change, and press **ENTER**.
3. Press **QUIT** to return to the Sonar Page.

## General Sub Tab

Use the **General** sub tab to select the water type, depth number, automatic scroll speed limit, scale, keel offset, and transducer type. The available General sub tab options are as follows:

- **Auto Gain**—controls the aggressiveness of the Auto Gain when the Gain option is set to **Auto**. The higher the setting, the greater the number of targets appear on the screen. The lower the setting, the less clutter on the screen. The settings are **Low**, **Medium** (default), and **High**.
- **Auto Color Gain**—controls what colors are applied to the objects on the screen when the Color Gain option is set to **Auto**. **Color DCG™** is based on depth and makes it easier to spot subtle changes in bottom conditions or fish sizes. **DynaColor™** (default) represents the latest in sonar data presentation and is recommended for all applications. The presentation is based on bottom strength. It makes the bottom and the fish easier to see and requires fewer adjustments.
- **Automatic Scroll Speed Limit**—automatically adjusts the scroll rate with the speed of your vessel. Entering your maximum cruising speed produces a 100% scroll rate when you reach that speed. One half of that speed produces a 50% scroll rate, and so on. The default is **30.0 kt**.
- **Keel Offset**—allows you to offset the surface reading for the depth of a keel. This makes it possible to measure depth from the bottom of your keel instead of from a transducer's location near the water line. Enter a positive number to offset for a keel. You can also enter a negative number to compensate for a large vessel that may draw several feet of water, requiring the transducer to be submerged if you want to measure from the water line. The **Keel Offset** is reflected in the depth reading.

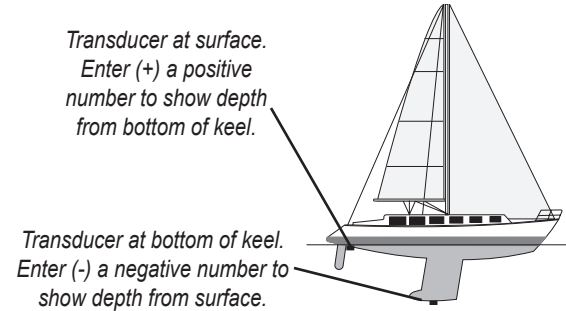

- **Transducer Type**—allows you to specify what type of transducer you are using, either **Dual Beam** or **Dual Frequency**.
- **Calibrate Water Speed**—this is available only if you are using a speed-capable transducer/sensor. Calibration is required to ensure that the Water Speed shown on your unit is accurate. The unit automatically uses the GPS ground speed, if it is available, for comparison on the calibration. If a GPS ground speed is not available, use either your boat's speedometer reading (not always accurate) or a stopwatch to determine your speed over a certain distance ( $\text{distance} / \text{time} = \text{speed}$ ). It is recommended that you calibrate in water having little or no current.

### To calibrate the water speed:

1. On the **Sonar** tab, press the **Cal Water Spd** soft key.
2. Bring the boat to cruising speed. Both the top ground and uncalibrated water speeds are shown at the bottom of the calibration window. Note your top speed, stop the boat, and press **ENTER**.
3. By default, the top ground speed automatically appears in the “**What was your top water speed?**” field. If a ground speed is not available, the top uncalibrated water speed is used instead. If the new speed is correct, highlight **OK**, and press **ENTER**. If you want to manually enter a calibration, press **ENTER** on the speed field, enter a new speed, and press **ENTER**.

### Graph Sub Tab

Use the Graph sub tab to select the color scheme, fish symbols, and scale.

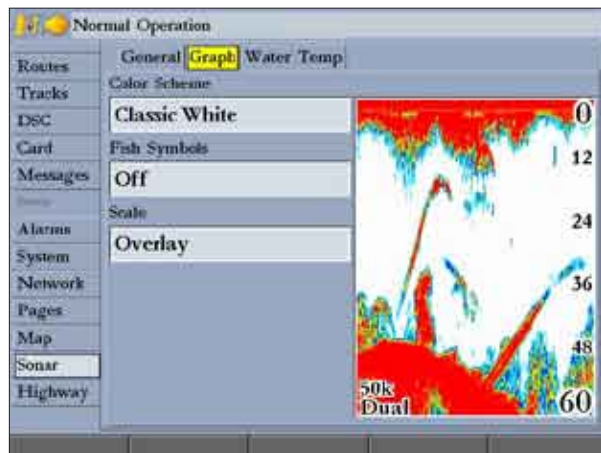



The available Graph sub tab options are:

- **Color Scheme**—sets the colors for the Sonar and Flasher Pages.
- **Fish Symbols**—sets how the Sonar Page interprets suspended targets and background information. If you select a fish symbol, the GPSMAP 3006C/3010C identifies some returns for you by replacing them with fish symbols (in large, medium, and small sizes based on the size of the sonar return). If you are using dual beam, fish symbols from the narrow beam (directly underneath your boat) are solid, and the returns from the wide beam (out to the sides of your boat) are hollow.

**Off** the Sonar Page does not interpret the sonar return data.

 Suspended targets appear as symbols. No background information appears

 Same as previous with the target depth shown.

 Suspended targets appear as symbols. Background information appears, making the distinction between fish and structure easier.

 Same as previous with target depth shown.

- **Scale**—controls the appearance of the depth scale shown vertically along the right side of the graph. You can configure the depth scale to appear in one of four different ways: as an **Overlay**, in the **Corners**, **Basic**, or **No Scale**.

## Water Temp Sub Tab

The Water Temp sub tab enables you to control the temperature log (if your boat is equipped with a temperature transducer/sensor). The graph reads from right to left, so that the most recent temperature measured appears on the far-right side of the log. The dotted lines within the graph indicate intervals in the temperature scale and the duration of time.

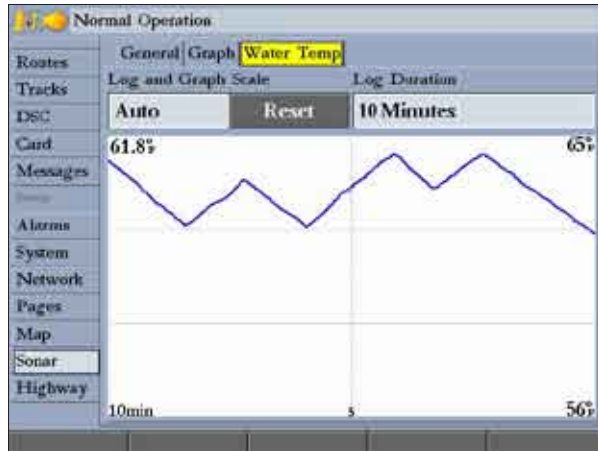

The following settings are available:

- **Log and Graph Scale**—sets the temperature range (in degrees) to display on the log and on the Sonar Page. Select **Auto** to have the unit automatically determine the best range, or select a Span of **2, 4, 6, 8, or 10** degrees.
- **Log Duration**—sets how fast or slow the temperature log scrolls (the shorter the time duration, the faster the temperature log scroll). Select a duration from **1 Minute to 2.5 Hours**. **10 Minutes** is the default.
- **Temperature Log**—records the water temperature as you move through the water so that you can look for temperature changes over a period of time.

## XM WX WEATHER

This section covers the additional XM WX Weather options for the GPSMAP 3006C/3010C when used with the GDL 30/GDL 30A Marine Weather/Audio Satellite Receiver. Read the *GDL 30/GDL 30A Owner's Manual* to properly install the GDL 30.



**NOTE:** You must have a GDL 30 Marine Weather Satellite Receiver installed and connected to your GPSMAP 3006C/3010C, and a subscription to XM WX Weather to use the XM WX Weather features.

When a GDL 30 Marine Weather Satellite Receiver is connected to the GPSMAP 3006C/3010C, and either the **Auto-Detect Services** or **Weather** checkbox is selected on the **System** tab, weather options are shown on the Map Page.



Map Page with XM WX Weather

## Customizing Preset Weather Displays

When you turn on weather and sea surface features, they appear on the Map Page. You can customize up to three weather presets. Default names are General, Sea State, and Storms, but each weather preset name can be changed. On the Map Page, press the **Next Preset** soft key to view each weather preset.

The setup page for each weather preset contains three tabs: Precipitation, Atmosphere, and Sea Surface.

- **Precipitation**—set ranges for NEXRAD/cloud tops, storm cells, lightning, and hurricanes. Settings include **Off**, **All Ranges**, or from **30 ft to 800 nm**.
- **Atmosphere**—set ranges for wind, pressure, visibility, fronts, and city conditions. Settings include **Off**, **All Ranges**, or from **30 ft to 800 nm**.
- **Sea Surface**—set ranges for temperature, wave height, wave period, and wave direction. Settings include **Off**, **All Ranges**, or from **30 ft to 800 nm**.

### To access weather setup options from the Main Menu

1. Highlight the **Weather** tab, and then highlight the Setup sub tab.
2. Highlight the on-screen button for the weather preset you want to customize, and press **ENTER**.



### To access weather setup options from the Map Page:

1. On the Map Page, press the **Wthr Options** soft key. Additional weather soft keys appear along the bottom of the page, and the name of the selected weather preset appears in the lower-left corner.
2. Press the **Next Preset** soft key to select a different weather preset.  
OR  
Press the **Weather Setup** soft key. Setup information for the current weather preset appears.

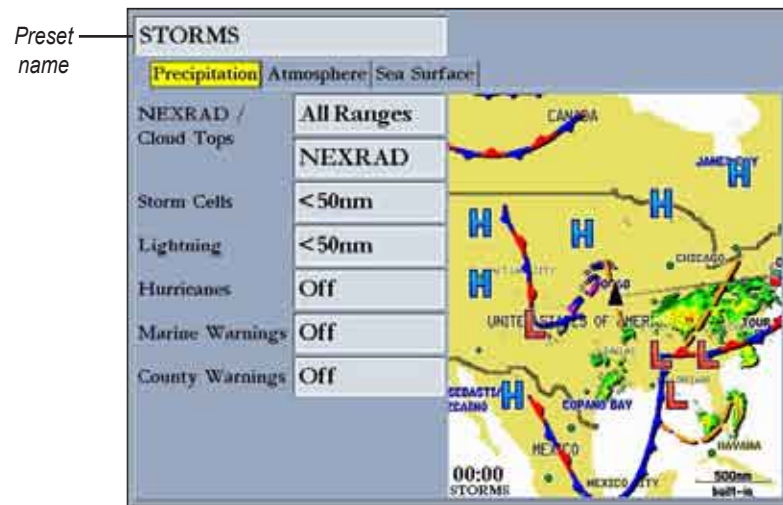

### To change the name of the preset:

1. Use the **ROCKER** to highlight the name of the preset, and press **ENTER**.
2. Press up or down on the **ROCKER** to change the name, and press **ENTER** when finished. The preset name is updated in the lower-left corner of the map window.

### To customize the preset weather options:

1. Select the weather preset you want to customize.
2. Select the tab you want to customize (**Precipitation**, **Atmosphere**, or **Sea Surface**).
3. Highlight the field you want to change, and press **ENTER**.
4. Select the range, and press **ENTER** again.

## Weather Tab

Use the **Weather** tab on the Main Menu to set up or view weather options. The Weather tab has six sub tabs: Current, Forecast, Sea Surface, Marine Bulletins, Forecast Map, and Setup.

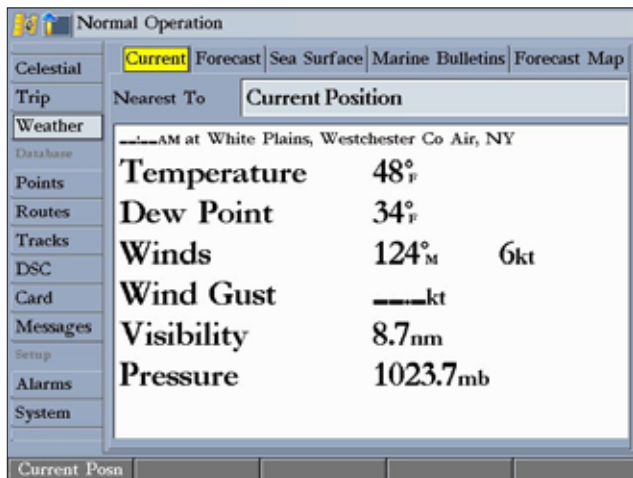

### To access the Weather tab:

1. Press and hold **ADJ/MENU** to open the Main Menu.
2. Press up or down on the **ROCKER** to highlight the **Weather** tab.
3. Press **QUIT** to exit the Main Menu and return to the previous page.

### Current Sub Tab

The Current sub tab shows current weather conditions observed at a weather data location closest to your current location or to any other city, waypoint, or location you select. It also shows the time at which the observation was made.

### To find weather conditions at other locations

1. Highlight the **Nearest To** field, and press **ENTER**. The Find Weather Information Page appears.
2. Highlight a search option, and press **ENTER**. The sub tabs show weather information for the selected location.

### Forecast Sub Tab

The Forecast sub tab displays forecast information for the selected city, waypoint, or location. It is divided into two panels. The top panel shows the high/low temperature, precipitation, and weather condition forecasts for the next few days' forecast. The number of days that appears in this panel depends on the data available from the responding weather service center.

The bottom panel features a detailed 24-hour forecast for windows, wind gust, and visibility. If more than four days appear, use the scroll bar to view additional days.

### Sea Surface Sub Tab

Use the Sea Surface sub tab to view weather data from buoys nearest to your current location or another specified location.

### Marine Bulletins Sub Tab

Use the Marine Bulletins sub tab to view marine bulletins nearest your current location.

### Forecast Map Sub Tab

The Forecast Map sub tab shows fronts, high and low pressure centers, and city conditions.

### Setup Sub Tab

Use the Setup sub tab to customize preset weather displays and view legends for all weather conditions.



## USING RADAR

This section covers the features and operation of the GMR 20/40 GMR 21/41, or GMR 404/406 marine radar when networked with your GPSMAP 3006C/3010C. Read the installation instructions included with your Garmin Marine Radar to install and configure your GMR 20/40 GMR 21/41, or GMR 404/406.



**NOTE:** You must have a GMR 20/40, GMR 21/41, or GMR 404/406 marine radar installed and connected to your GPSMAP 3006C/3010C to use the radar features.

### Understanding Radar

The Garmin marine radar transmits a narrow beam of microwave energy in a rotating 360° pattern. When the transmitted energy contacts a target, some of that energy is reflected and returned to the scanner. The scanner collects the returned energy for processing and display. Your GMR 20/40, GMR 21/41, or GMR 404/406 is operated and adjusted using controls on your GPSMAP 3006C/3010C. You can view radar data on the Radar Page or as an overlay on the Map Page.

When you turn on the radar, the status bar shows the message “Radar Warming Up” with a countdown to Standby Mode. The countdown also appears in the middle of the Radar Page. When the countdown reaches 0 (zero), the “Hold FCTN to transmit” message appears.

As a safety feature, the radar enters Standby Mode after it warms up. This gives the operator an opportunity to verify that the area around the scanner is clear before beginning radar transmission. It is important to remember that the microwave energy transmitted by the scanner can potentially be dangerous.



**CAUTION:** The marine radar transmits microwave energy that has the potential to be harmful to humans and animals. Before beginning radar transmission, verify that the area around the radar is clear. The radar transmits a beam approximately 12° above and below a line extending horizontally from the center of the scanner. Avoid looking directly at the scanner, because the eyes are the most susceptible part of the body.

When the area surrounding the scanner is clear, press and hold FCTN. The message “Do you want to begin radar transmission?” is shown. Select **Yes**, and then press **ENTER**.

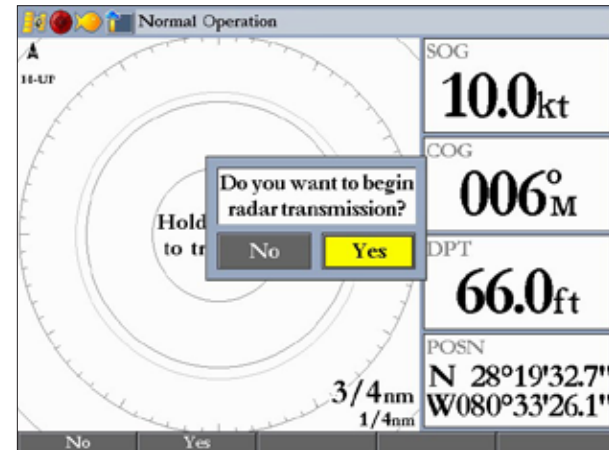

Before transmission begins, the message “Spinning Up” is shown while the radar antenna reaches nominal rotation speed. After the message disappears, the radar begins painting an image.

### Understanding the Radar Display

The Radar Page shows a status bar along the top, user-configurable digital navigation data down the right side, a Heading Line, and Range Rings. Soft keys that allow quick access to radar functions and setting changes appear along the bottom of the page.

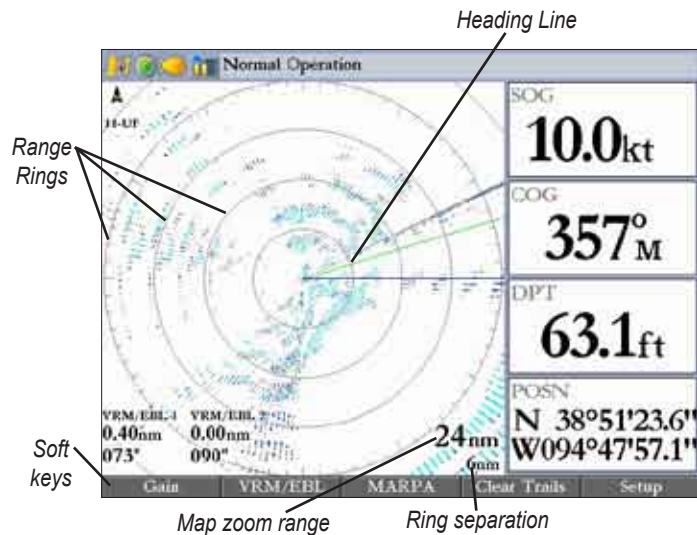

### Using Range Rings

Use the Range Rings to quickly determine the distance to a target. The lower-right corner of the screen contains two scales. The scale value represents the distance from the center of the radar display to the outermost complete ring. The top scale represents this value. The bottom scale represents the ring separation or the distance between the Range Rings. Use the RANGE keys to zoom in or out. The tick marks on the Range Rings are arranged with major tick marks at 30 degree increments and minor tick marks every five degrees. The tick marks can help in quickly determining the azimuth to a target.

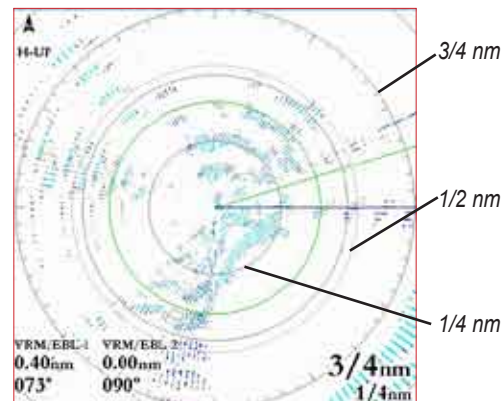

### Heading Line

The Heading Line is shown from your current position along the path of your current heading.

## Radar Page

With the radar properly installed, when you turn on your GPSMAP 3006C/3010C, it should detect the radar as a new network connection.



**NOTE:** A software update may be needed for the radar to function properly. If the message “Incompatible Software Version” appears when you turn on the GPSMAP 3006C/3010C, you must update your GPSMAP 3006C/3010C software. A software update card is provided with the radar.

When the new radar is detected, the Radar Page is added to the page sequence. If the Radar Page is not available, press and hold **ADJ/MENU** to open the Main Menu. Highlight the **System** tab, and select **Radar** from the Services list at the bottom of the page.

### To view the Radar Page:

Press **PAGE** repeatedly until the Radar Page appears.

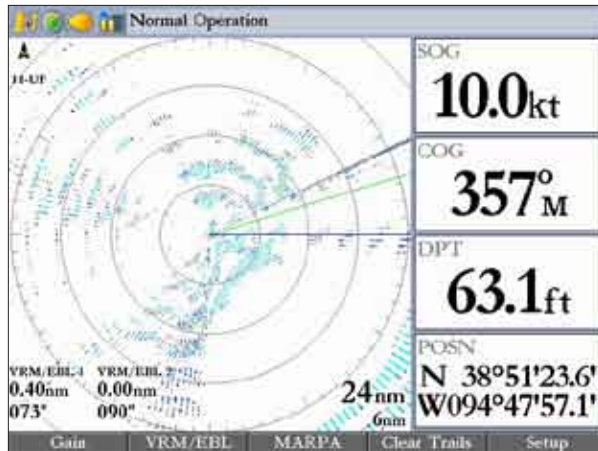

Radar Page

## Configuring the Radar Page

You can customize the appearance of the Radar Page. See “Configuring Main Pages” on [page 33](#) for more information.

### To add or remove functions on the Radar Page:

1. Open the Radar Page, and then press and hold the **DATA/CNFG** key to open the Configuration window.



2. Using the **ROCKER**, highlight the function you want to add or remove, and press **ENTER**. Only functions with a check mark in the check box next to them appear on the Radar Page.

## Using the Radar Adjustment Menu

Use the Radar adjustment menu to access the settings and features most commonly used on the Radar Page including: Gain, Sea Clutter, Rain Clutter, FTC, Zoom, Target Expansion, Trails, Guard Zone, VRM/EBL, MARPA, and Hide/Show Navigation Features.

### To select an adjustment option from the Radar Page

1. Press **ADJ/MENU** to open the Radar adjustment menu.

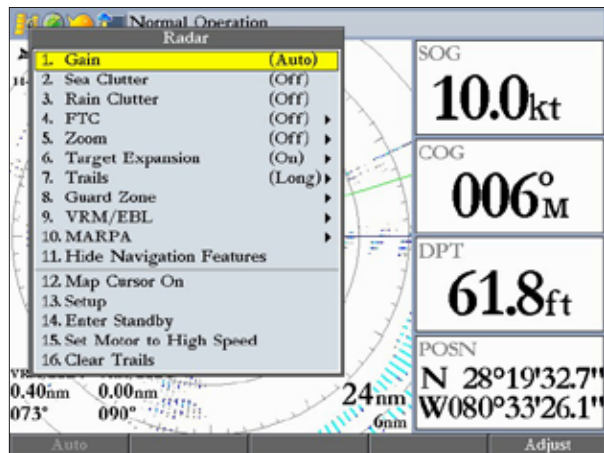

2. Press up or down on the **ROCKER** to highlight the option you want to change, and then press **ENTER**.

### To change a Radar adjustment menu setting:

1. Select an adjustment menu option using the method described previously.
2. Press up or down on the **ROCKER** to change the setting, range, or percentage.
3. Press **ENTER** to accept the change, or press **QUIT** to close the Radar adjustment menu.

### Gain

Gain controls the sensitivity of the radar receiver. **Auto** (default) is the recommended setting. It automatically adjusts the gain to provide optimal performance. You can also set gain manually. To see more detail, increase the receiver sensitivity by selecting a higher gain. If there is too much detail, or the screen is cluttered, lower the sensitivity (lower the gain) to increase the clarity of the screen.

### Sea Clutter

Sea Clutter controls unwanted screen clutter caused by choppy sea conditions. The slider has three preset positions: **Calm**, **Moderate**, and **Rough**.

### Rain Clutter

Rain Clutter controls unwanted screen clutter caused by rain at close ranges (use the slider to select 1-100%).

### FTC (Fast Time Constant)

FTC controls unwanted screen clutter caused by rain at a distance. The Fast Time Constant has four settings: **Off**, **Low**, **Medium**, and **High**.

## Zoom

Zoom allows you to zoom in on a selected area of the radar screen. When you select a zoom range, a window showing a zoomed portion of the screen appears in the lower-left corner and a selection box appears. To view different areas at the selected zoom range, open the Radar adjustment menu, and then press the **Move** soft key. Use the **ROCKER** to move the selection box. The Zoom setting has four settings: **Off**, **2x**, **4x**, and **Move**.

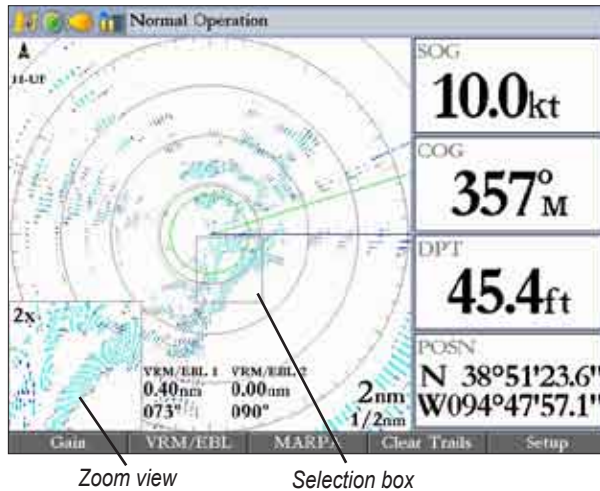

## Target Expansion

Use Target Expansion to increase the size of a target. Select **On** or **Off**.



**NOTE:** The Target Expansion setting has no effect at range scales of 4 nm or greater.

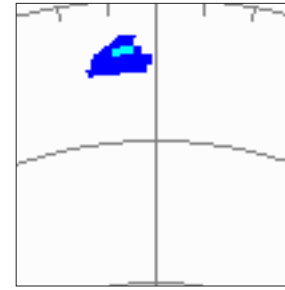

Target Expansion Off

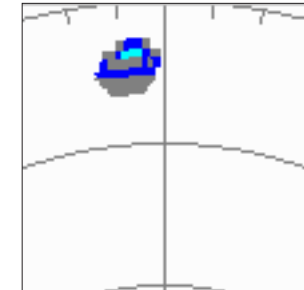

Target Expansion On

## Trails

Trails allows you to select whether all returns on the screen leave a history trail, and allows you to determine the length of the history trail (**Off**, **Short**, **Medium**, or **Long**).

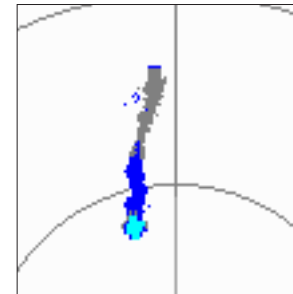

Trails On

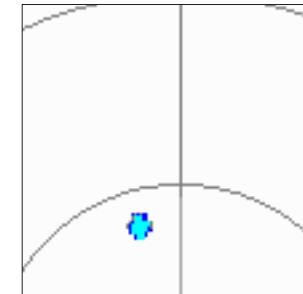

Trails Off

## Guard Zone

A Guard Zone is a user-defined area of protection. If a target enters the Guard Zone, an alarm sounds. You can define two Guard Zones. The Guard Zone Menu has two areas, “Guard Zone 1” and “Guard Zone 2.” Each area has two settings, **Show (Hide)** and **Adjust**.

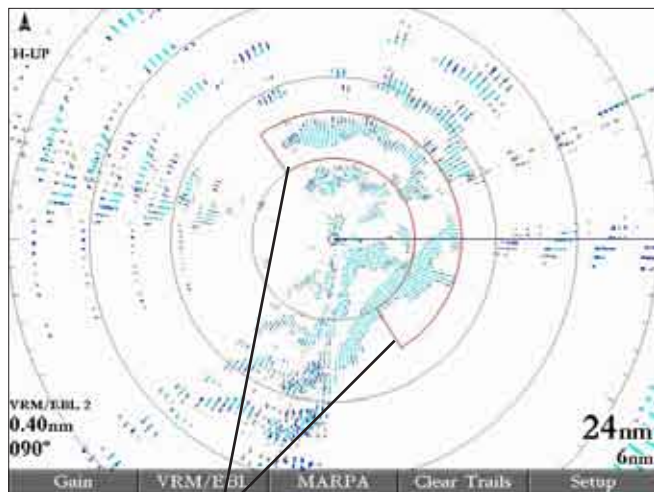

Guard Zone

### To Define a Guard Zone:

1. Highlight **Show Guard Zone 1 or 2**, and press **ENTER**.
2. Highlight **Adjust**, and press **ENTER**.
3. Using the **ROCKER**, define the area on the Radar Page by adjusting three points:
  - Corner 1
  - Corner 2
  - Circular
4. Press **ENTER** to set the Guard Zone.

## VRM/EBL

The Variable Range Marker (VRM) and Electronic Bearing Line (EBL) tools measure range and bearing to a target. You can move the center point of the VRM, which allows you to measure from one target to another. Two VRM/EBL tools can be active at the same time.

The VRM/EBL option has two areas, VRM/EBL 1 and VRM/EBL 2. Each area has two settings, **Show (Hide)** and **Adjust**.

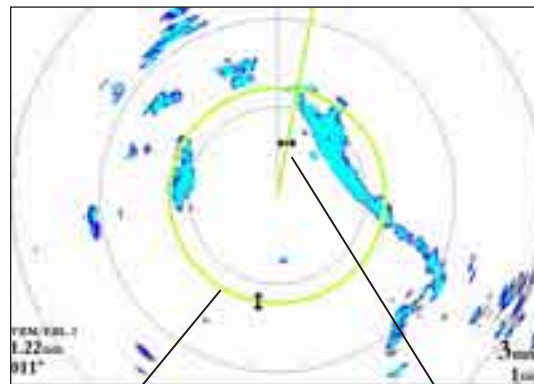

Variable Range Marker (VRM)

Electronic Bearing Line (EBL)

### To start VRM/EBL 1 or VRM/EBL 2:

On the Radar Adjustment menu, highlight **Show VRM/EBL 1 or VRM/EBL 2**, and then press **ENTER**.

You can adjust the diameter of the VRM and the angle of the EBL.

**To adjust the VRM/EBL:**

1. Highlight **Adjust**, and press **ENTER**.
2. Press right or left on the **ROCKER** to rotate the EBL around the center point of the VRM.
3. Press up or down on the **ROCKER** to increase or decrease the size of the VMR.
4. Press **ENTER** to accept the changes.

**To move the center location of the VRM:**

1. Highlight **Move**, and press **ENTER**.
2. Using the **ROCKER**, move the center point of the VRM to the selected location.
3. Press **ENTER** to set the new location.

To use the VRM/EBL, expand the diameter of the VRM so that the outer edge touches the target. Rotate the EBL until it intersects the VRM at the target location. The measured range and bearing are displayed in the lower-left corner of the screen.

**MARPA**

The Mini Automatic Radar Plotting Aid (MARPA) function helps with collision avoidance. MARPA can track up to 10 designated targets. Detailed information including bearing, range, course, speed, closest point of approach (CPA), and time to closest point of approach (TCPA) for each target is shown in the MARPA list.



**NOTE:** MARPA requires the use of a heading sensor. The heading sensor must output the NMEA sentence HDM or HDG at format 0183, v2.30 or higher. The Gamin Marine Network has been tested using the KVH® 1000 heading sensor using six second dampening.

MARPA relies on a heading sensor to provide accurate own vessel heading information. Accurate heading data enhances MARPA's performance. Each target being tracked by MARPA is represented by a symbol. The symbols indicate the current state of the target.



For each target, a number and Vector Line is shown with the symbol. The number is the MARPA list ID number. The Vector Line is a visual reference of the target's course and speed.

**To designate a MARPA target:**

1. Use the **ROCKER** to move the pointer to the target location.
2. Press the **Acquire Target** soft key.

While a target is being designated, a red box appears around the target. When MARPA begins tracking the target, the box is replaced with the appropriate symbol.

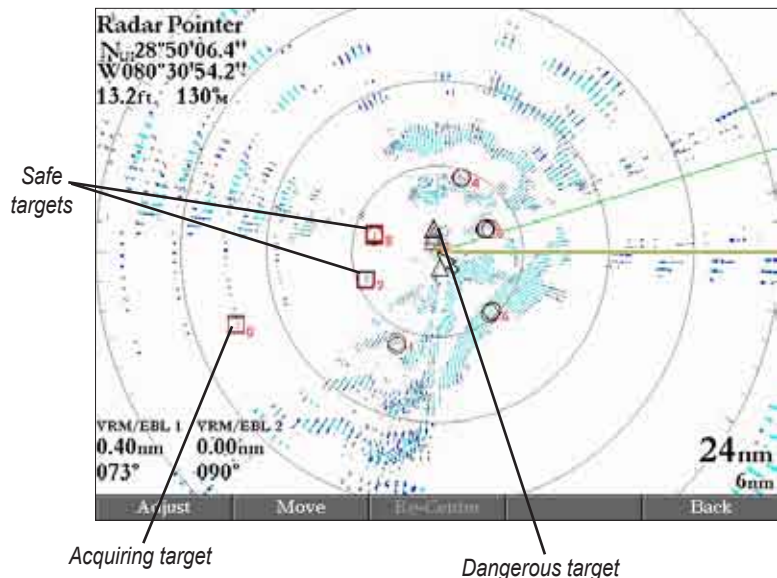

### Enter Standby (Begin Transmitting)

The **Enter Standby (Begin Transmitting)** option allows you to select if the radar is in Standby Mode or is transmitting. Select **Enter Standby** to place the radar into Standby Mode. While in Standby Mode, the radar does not transmit, but power remains applied to the Magnetron. Select **Begin Transmitting** to remove the radar from Standby Mode. After the radar completes “Spinning Up”, the radar begins transmitting.

### Set Motor to High Speed (Set Motor to Normal Speed)

The **Set Motor to High Speed (Set Motor to Normal Speed)** option allows you to select the motor speed of the GMR 404/406 radar. Selecting **Set Motor to High Speed** to increases the speed at which the radar rotates, thus increasing the speed at which the screen updates.



**NOTE:** This option is available only if you are using a GMR 404/406 Radar.

### To view the MARPA List:

Press the **MARPA List** soft key.

ID	Bearing	Range	Course	Speed	CPA	TCPA
0	184°	5.3nm	000°	1.2kt	0.3nm	04:18:04
1	286°	4.6nm	116°	0.3kt	1.5nm	21:30:59
2	174°	1.9nm	304°	3.6kt	1.5nm	00:20:49
3	004°	3.4nm	277°	1.7kt	3.4nm	Passed
4	202°	7.6nm	139°	6.6kt	6.7nm	Passed
5	188°	10.0nm	099°	12.4kt	10.0nm	Passed
6	173°	8.5nm	294°	105kt	7.3nm	00:02:29
7	087°	1.6nm	257°	126kt	0.3nm	00:00:45
---	---	---	---	---	---	---
---	---	---	---	---	---	---



## Map Page Radar Overlay

Radar information can be shown as an overlay on the Map Page. When you overlay radar information on the Map Page, you can press **ADJ/MENU** to access many of the radar options.



**NOTE:** Changing the map zoom scale does not change the radar range. When you zoom in or out on the Map Page, the radar overlay is scaled to fit.

### To overlay radar data on the Map Page:

On the Map Page, press the **Show Radar** soft key.

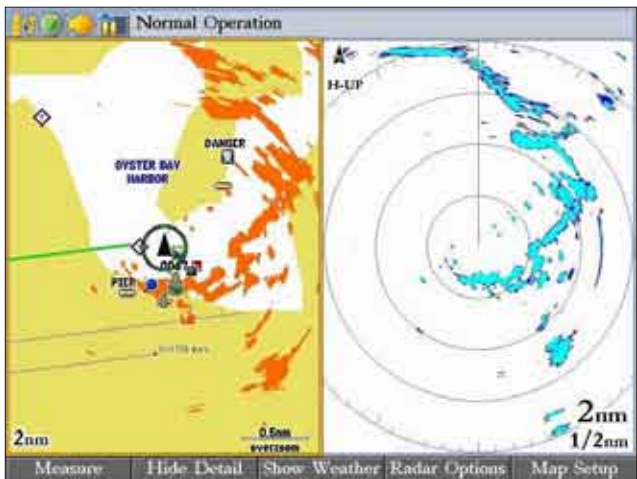

Map Page with Radar Overlay and Radar Page

### To hide the radar data overlay on the Map Page:

1. Press the **Radar Options** soft key.
2. Press the **Hide Radar** soft key. The radar overlay is hidden.

## Radar Tab

When a GMR 20/40, GMR 21/41, or GMR 404/406 Marine Radar is connected to the GPSMAP 3006C/3010C, and either the **Auto-Detect Services** or **Radar** check box is selected on the System tab, the Radar tab appears on the Main Menu.

Use the Radar tab to set up the Radar Page. The Radar tab has four sub tabs: General, Display, MARPA, and Advanced.



### To access and change a setting on the Radar tab:

1. Press the **Setup** soft key on the Radar Page to open the Main Menu. The Radar tab is automatically selected.
2. Highlight the setting you want to change, and then press **ENTER**.
3. Press **QUIT** to return to the Radar Page.

## General Sub Tab

Use the General sub tab to select orientation, timed transmit, and cross-talk rejection. The available General sub tab options are:

- **Orientation**—sets the orientation of the Radar Page. The settings are **Heading Up**, **North Up**, or **Course Up**.
- **North Indicator**—toggles the north indicator arrow on or off.
- **Timed Transmit**—used to save power, usually while at anchor. When Timed Transmit is **On**, the radar uses the settings in **Timed Transmit XMIT Time** and **Timed Transmit STBY Time** fields. When Timed Transmit is **Off**, these fields are unavailable.
- **Timed Transmit XMIT Time**—sets the amount of time (in minutes) for which the radar transmits. For example, if set to 01 min, the radar transmits for one minute before switching to the amount of time entered in the **Timed Transmit STBY Time** field.
- **Timed Transmit STBY Time**—sets the amount of time (in minutes) that the radar is in standby mode. For example, if set to 10 min, the radar is in standby mode for 10 minutes before switching to the amount of time entered in the **Timed Transmit XMIT Time** field. When the radar is in standby mode, the scanner does not rotate or transmit; however, power is still applied to the Magnetron, eliminating the need for a warm-up cycle.
- **Cross-talk Rejection**—toggles cross-talk rejection on or off. Radar cross-talk may occur when two or more radar equipped vessels are operating in proximity to one another. Cross-talk rejection automatically filters out the cross-talk interference.

## Display Sub Tab

Use the Display sub tab to adjust settings for: Center Offset, Rings, Background color, Heading Line, Bearing Reference, and Navigation Features.

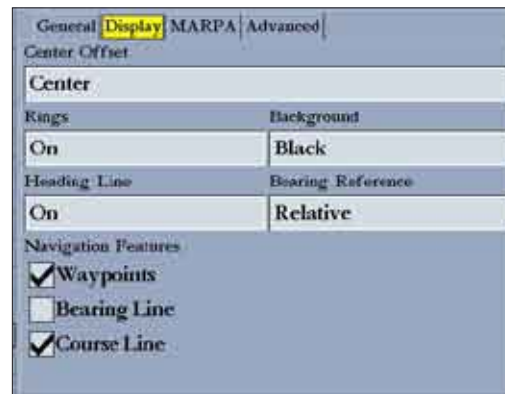

The available Display sub tab options are:

- **Center Offset**—sets your location on the screen. **Center** places your current location in the center of the screen. **Look Ahead** shifts your current location toward the bottom of the screen, allowing you to view an area farther ahead. **Auto Shift** adjusts your location on the screen according to the current speed.
- **Rings**—toggles the radar rings on or off.
- **Background**—sets the background color for the Radar Page. Available options are **Black**, **Blue**, or **White**.
- **Heading Line**—toggles the heading line on or off.

- **Bearing Reference**—sets your bearing, either **Absolute** or **Relative**. **Relative** calculates the bearing relative to own vessel heading. **Absolute** calculates the bearing referring to North.
- **Navigation Features**—allows you to show or hide navigational features on the Radar Page. Use the **ROCKER** and the **ENTER** key to select or clear options.
  - **Waypoints**—show user waypoints on the Radar Page.
  - **Bearing Line**—show a bearing line on the Radar Page. The bearing line appears as a line from your current position to the active destination waypoint, similar to a traditional lollipop.
  - **Course Line**—show a course line from your starting point to the active destination waypoint, which is similar to navigation on a map.

### MARPA Sub Tab

The MARPA sub tab contains settings for Vector Length, Target History, Own Vessel Safe Zone, Time To Safe Zone, Safe Ring Zone, and Velocity Reference.

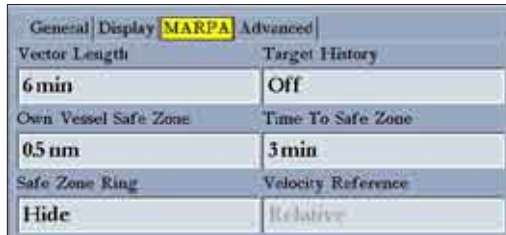

The available MARPA sub tab options are:

- **Vector Length**—predicts the target’s approximate position at a set time interval. This setting determines the length of the Vector Line, based on the time interval setting and the target’s speed. The time interval settings range from .05 minutes to 60 minutes.
- **Target History**—is a trail showing a target’s movement. Target History can be turned **On** or **Off**.
- **Own Vessel Safe Zone**—is a circular area defined by a range setting that is centered on your own vessel. If a target enters the defined area an alarm is sounded. The Safe Zone can be set to a distance between .01 and 2 nautical miles.
- **Time To Safe Zone**—sounds an alarm if MARPA determines that a target will intersect the Own Vessel Safe Zone within the defined time interval. The time interval settings range from 3 to 24 minutes.
- **Safe Zone Ring**—displays a ring on the Radar Page depicting the Own Vessel Safe Zone.
- **Velocity Reference**—has two settings, **Absolute** and **Relative**. This setting determines how speed and direction are displayed on the MARPA list. Relative calculates target speed and direction relative to your own. **Absolute** shows the target’s actual speed.

## Advanced Sub Tab

Use the Advanced sub tab to set AFC Mode, front of boat offset and antenna size.



**NOTE:** The **Antenna Size** field is available only if you are using a GMR 404/406 Marine Radar.

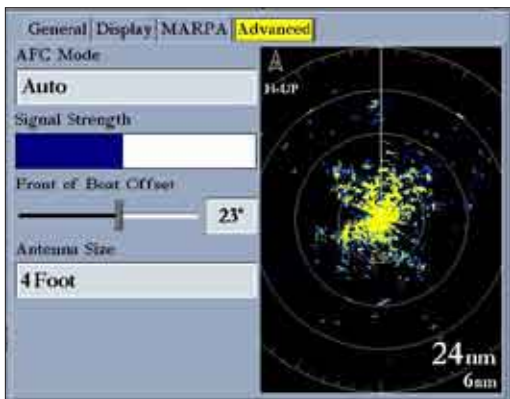

The available Advanced sub tab settings are:

- **AFC Mode**—sets how the scanner frequency is adjusted. Select **Auto** to automatically adjust the scanner frequency for optimal performance (recommended). Select **Manual** to set the frequency manually.

### To manually adjust the scanner frequency:

1. Highlight the **AFC Mode** field, and press **ENTER**.
2. Select **Manual**, and press **ENTER**.
3. Highlight the **Freq** button to the right of the **AFC Mode** field, and press **ENTER**.



**NOTE:** The **Freq** button is available only available if **Manual** is selected in the **AFC Mode** field.

4. Press up or down on the **ROCKER** to adjust the scanner frequency.
5. Press **ENTER** to accept the frequency change.



**NOTE:** The Signal Strength bar graph is damped and may be slow when responding to frequency tuning changes.

- **Signal Strength**—shows the strength of the radar signal
- **Front of Boat Offset**—allows you to offset the front of the boat if you mount the radar at an angle.
- **Antenna Size**—allows you to select the size of your antenna (**4 Foot** or **6 Foot**).



**NOTE:** This field is available only if you are using a GMR 404/406 Radar. Select **4 Foot** for a GMR 404 Radar; select **6 Foot** for a GMR 406 Radar.

## APPENDIX

### Specifications

#### *Physical Specifications*

**Size:** GPSMAP 3006C: 6.5" H x 10.3" W x 3.3" D (16.5 x 26.2 x 8.4 cm)  
GPSMAP 3010C: 8.8" H x 13.1" W x 3.0" D (22.4 x 33.3 x 7.6 cm)

**Weight:** GPSMAP 3006C: 3.0 lbs (1.4 kg)  
GPSMAP 3010C: 5.0 lbs (2.3 kg)

**Display:** GPSMAP 3006C: 6.4" diagonal (16.3 cm)  
GPSMAP 3010C: 10.4" diagonal (26.4 cm)  
High resolution, 256-color TFT (640 x 480 pixels), full VGA, with adjustable backlighting

**Case:** Fully gasketed, high-impact plastic alloy, waterproof to IEC 60529-IPX 7

**Temp. Range:** 5°F to 122°F (-15°C to 50°C)

#### *GPS Performance (with GPS 17)*

**Receiver:** Differential-ready 12 parallel channel WAAS-capable receiver

#### **Acquisition Times:**

**Warm:** Approx. 15 seconds

**Cold:** Approx. 45 seconds

**AutoLocate:** Approx. 2 minutes

**Update Rate:** 1/second, continuous

#### **GPS Accuracy:**

**Position:** <15 meters (49 feet), 95% typical\*

**Velocity:** 0.05 meters/sec steady state

#### **WAAS Accuracy:**

**Position:** <3 meters (10 feet), 95% typical\*

**Velocity:** 0.05 meters/sec steady state

**Dynamics:** 6gs

#### **Power**

**Source:** 10-33 V DC

**Usage:** 25 watts max. at 10 V DC

**Fuse:** AGC-3 - 3.0 Amp

## Installing and Removing Data Cards

The GPSMAP 3006C/3010C uses optional Garmin BlueChart® and MapSource® data cards. By updating your GPSMAP 3006C/3010C software® to version 4.0 or later, you can use optional preprogrammed BlueChart g2™ data cards.

Insert data cards in the card slots located on the left side of the unit. You can install or remove data cards at any time, whether the unit is on or off.

### To install a data card:

1. Open the card door by pressing the locking tab on the door toward the outside (left) of the unit and lifting the door open from right to left.
2. Insert the card into the slot, with the label facing to the right and the handle facing toward you.
3. Push the card into the unit. It is not necessary to force the card, and about 1/2" is still exposed when it is properly inserted. If the unit is on, a confirmation tone sounds, and a message appears on the screen noting the card details when the card is properly installed and accepted.
4. Close the cover until it locks.

If you insert a data card and receive a “card format not recognized” message, remove the card and reinsert it. If the card is still not recognized, contact Garmin Product Support or your Garmin dealer for assistance.



**NOTE:** Data cards are not waterproof, should not be exposed to moisture or excessive static charges, and should be stored in the case supplied with the card. Data cards are a Garmin proprietary device and are not exchangeable with the SD cards used for Garmin g2 Vision mapping data.

The first time you insert a data card, the unit takes a few seconds to read the card. After the data card is read, a summary page appears. Press **ENTER** to acknowledge.



### To remove a data card:

1. Open the card door by pressing the locking tab on the door toward the outside (left) of the unit and lifting the door open from right to left.
2. Grasp the card handle, and pull out firmly.
3. If the unit is on, a confirmation tone sounds when the data card is removed.

## Satellite Information

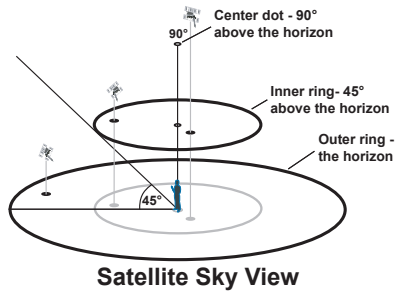

### Satellite Location

The location of each available satellite is shown over two location rings on the Satellite Information Page. The outer ring represents the horizon, the inner ring represents 45° above the horizon, and the center represents directly overhead. When the unit is using a satellite for navigation, the satellite number is highlighted on the location rings. The unit can display satellite location with North or your current track at the top of the display.

### Satellite Strength Indicator Bars

The Satellite Strength Indicator Bars show the strength of the signal being received and the status of the signal. The bars are either shaded or filled. A hollow gray bar means the unit is in the process of storing orbital data it is receiving from the satellite signal. When the bar turns solid green, the unit is using the satellite signal for navigation. A “D” in or above the bar means differential corrections (WAAS or DGPS) are being applied to that satellite.

### Date, Time, and Current Location

The unit gets date and time information from the satellite’s on-board atomic clock. When the unit has achieved a 2-D or 3-D GPS location, the current location is shown in the location format you have selected.

*GPSMAP 3006C/3010C Owner’s Manual*

## What is WAAS/EGNOS?

The Wide Area Augmentation System (WAAS) is an FAA-funded service to improve the overall integrity of the GPS signal for users in North America. In Europe, WAAS is referred to as EGNOS.

The system is made up of satellites and approximately 25 ground reference stations positioned across the United States that monitor GPS satellite data. Two master stations, located on either coast, collect data from the reference stations and create a GPS data correction message.

According to the FAA’s Web site, testing of WAAS in September 2002 confirmed an accuracy performance of 1–2 meters horizontal and 2–3 meters vertical throughout the majority of the continental United States and portions of Alaska.

WAAS is just one service provider that adheres to the Minimum Operational Performance Standard (MOPS) for global Satellite Based Augmentation Systems (SBAS). Eventually there will be several services of worldwide geostationary communication satellites that broadcast integrity information and differential correction data as transmitted by ground reference stations.

All SBAS systems use the same receiver frequency; therefore any operational SBAS system should be capable of providing your GPS unit with increased accuracy at any location in the world.

Currently, enabling WAAS on your GPSMAP 3006C/3010C in regions that are not supported by ground stations may not improve accuracy, even when receiving signals from an SBAS satellite. In fact, it can degrade the accuracy to less than that provided by GPS satellites alone. For this reason, when you enable WAAS on your Garmin GPS receiver, the receiver automatically uses the method that achieves the best accuracy.

For more information, go to [gps.faa.gov](http://gps.faa.gov).

## WAAS Capability

The GPSMAP 3006C/3010C is capable of receiving WAAS satellite signals. Effective use of the WAAS satellite signal may be limited by your geographic location in relation to those satellites, now in developmental service. WAAS satellite signal reception requires an absolute clear view of the sky and works best when there are no nearby obstructions such as buildings or mountains.

WAAS satellites are numbered 33 or higher when viewing the sky view on your GPSMAP 3006C/3010C. Initial reception of the WAAS signal may take up to 15-20 minutes, then 1–2 minutes afterwards. When WAAS differential correction has been received for GPS satellites (numbers 32 or below), a “D” appears in the signal bar of the sky view and “Ready For Navigation with WAAS” appears in the Status field. To learn more about the WAAS system, its satellite locations and current state of development, visit the FAA web site ([gps.faa.gov](https://www.faa.gov)). Because WAAS requires CPU resources of the GPSMAP 3006C/3010C to search for and track the satellites, you can disable the WAAS feature to improve unit performance if WAAS reception is not available in your area.

### To disable or enable WAAS capability:

1. On the **GPS** tab, highlight the **Setup** sub tab.
2. Use the **ROCKER** to highlight the **WAAS** field, and press **ENTER**.
3. Highlight **On** or **Off**, and press **ENTER**.

## Digital Selective Calling (DSC)

When your GPSMAP 3006C/3010C is connected to a VHF radio with DSC support, the GPS unit displays a Call List, Log, and a Directory to store incoming information received from another user’s DSC capable VHF/GPS combination. Basic wiring is required for the Garmin unit and VHF radio to send and receive NMEA data from each other. See the *GPSMAP 3006C/3010C & GPS 17 Installation Instructions*.

### What is DSC?

Digital Selective Calling (DSC) uses marine VHF radio and Global Positioning System (GPS) technologies to transmit and receive location information. DSC is used by mariners to assist them in two major areas: distress calls and position reporting.

A non-emergency DSC position report allows mariners to exchange and display the positions of one another. When a DSC position is received, the mariner can choose to create a waypoint or show the received position on an electronic map.

An emergency DSC distress call allows a vessel in trouble to transmit a substantial amount of information in a single transmission or “call” without the need for voice communication. When any nearby rescuer receives the DSC signal, an alarm sounds, and they immediately receive the position of the caller.

The rescuer can then choose to navigate (Go To) the caller’s position to assist or forward the call on to the Coast Guard. When the Coast Guard receives the call, they can immediately access the caller’s information (such as who they are and the type of vessel) in their database while they are in transit to the caller’s location.



Any time a vessel receives a DSC call, the vessel can store that location and quickly navigate to that position using a Go To. This makes DSC a time-saver, especially in an emergency situation. To use DSC, users must first register their VHF radio with the FCC and receive a Maritime Mobile Service Identity (MMSI) number.

### **What is a Maritime Mobile Service Identity (MMSI)?**

Maritime Mobile Service Identity (MMSI) allows a VHF radio to act like a phone. To make a “call” on a phone, you first need a phone number to dial. The 9-digit MMSI number acts like a phone number when used in a Position Report and as a unique identifier to the Coast Guard when used in an emergency distress call. To obtain a Maritime Mobile Service Identity (MMSI) number, users must register their VHF radio with the FCC (Form 605). **Garmin does not supply this number!**

### **How Are MMSI Assignments Obtained?**

Non-commercial users (recreational users who remain in domestic waters and only carry VHF, EPIRB (Emergency Position Indicating Radio Beacons, and Radar)) are not required to have a FCC ship station license. The FCC and Coast Guard have authorized some second and third-party vendors to assign MMSI numbers. This service is limited to registering recreational vessels only. To receive information on how to obtain a recreational MMSI number, visit [www.navcen.uscg.gov/marcomms/gmdss/mmsi.htm](http://www.navcen.uscg.gov/marcomms/gmdss/mmsi.htm) or [wireless.fcc.gov/marine/](http://wireless.fcc.gov/marine/).

### **Non-Federal Users in the United States**

Commercial users, or those who travel outside the U.S.A. or Canada, must apply for a ship station license, or an amendment to a ship station license. To find out if you require a Ship Station license, visit [wireless.fcc.gov/marine/ftsht14.html](http://wireless.fcc.gov/marine/ftsht14.html). If your vessel requires licensing by the FCC, you can obtain a MMSI during the application/licensing process when you file FCC Forms 159 and 605.

### **Federal Users in the United States**

Federal users can obtain MMSI assignments from their agency radio spectrum management office. These procedures are currently under review by the NTIA (National Telecommunications and Information Administration).

### **Users Outside the United States**

Users can obtain an MMSI assignment from their telecommunications authority or ship registry, often by obtaining or amending their ship station license.

### **Users in Canada**

Industry Canada is responsible for assigning MMSI numbers to commercial and recreational vessels. Information is available at the following Web site: [www.ccg-gcc.gc.ca/mcts-sctm/docs/mmsi/MMSI\\_e.htm](http://www.ccg-gcc.gc.ca/mcts-sctm/docs/mmsi/MMSI_e.htm).

For more information regarding MMSIs visit: [www.navcen.uscg.gov/marcomms/gmdss/mmsi.htm](http://www.navcen.uscg.gov/marcomms/gmdss/mmsi.htm).

### **How Can Garmin Help You with DSC?**

To receive Distress Calls or Position Reports, you must have a DSC-equipped chartplotter as well as a VHF radio with DSC support. During normal, non-emergency Position Report communication, Channel 70 (156.525 MHz) has been set aside as the VHF/DSC digital call channel.

For a Distress Call, a mariner presses the MayDay button on the VHF radio. The call transmits on an emergency channel with the MMSI number attached to the call (if you have DSC support). Any DSC-equipped mariner (on sea or land) within range can receive the call.

## LORAN TD System

LORAN-C is a radio navigation aid operated and maintained in the United States by the United States Coast Guard. The LORAN (LOng RAnge Navigation) system covers the entire United States and the U.S. Coastal Confluence Zone. From the perspective of a mariner, the system is used for ocean and coastal navigation. It can be used as a supplemental system for harbor and harbor approach navigation, and it is used for inland navigation by recreational vehicles.

### LORAN TD Feature

The LORAN TD (Time Delay) feature eases the transition from using LORAN to using GPS. The GPSMAP unit automatically converts GPS coordinates to LORAN TD for those who have a collection of LORAN fixes for favorite fishing spots and other waypoints recorded as TDs. You can display your position as a TD or enter waypoints as TDs. The accuracy to be expected from this conversion is approximately 30 meters. When the unit is placed in the LORAN TD format mode, it simulates the operation of a LORAN receiver. Position coordinates may be displayed as TDs, and all navigation functions may be used as if the unit was actually receiving LORAN signals.

### Using the LORAN TD Format

When creating new waypoints using LORAN TD coordinates, you must set the correct LORAN chain number and secondary stations in the **Setup TD** field before storing a waypoint. You must have the correct chain number as well as the secondary station identifiers to use this option correctly. These values vary for each coordinate set or geographical location. Failure to enter correct information could result in inaccuracies for the desired destination. After the waypoint is stored in the unit's memory, it always references the LORAN chain number and secondary stations currently selected in the **Setup TD** field. If you enter a different LORAN chain number, change the secondary stations or offsets in the Setup TD field, the active waypoint information reflects those changes.

Because the GPSMAP 3006C/3010C unit does not rely on the LORAN signal for navigation, it can reference a different GRI chain or secondary stations and still navigate to the location stored in memory.

The LORAN Position Format field is located on the Units sub tab on the Main Menu—System tab. The Loran TD Setup window contains the fields to select the LORAN Chain Number, Primary and Secondary Stations, and TD Offsets.

#### To set up LORAN TD from the Main Menu:

1. Using the **ROCKER**, highlight the **System** tab, press right on the **ROCKER** to highlight the **Units** sub tab. Highlight the **Position Format** field, and press **ENTER**.
2. Highlight **Loran TD**, and press **ENTER**, and then highlight the **Setup** button to the right, and press **ENTER** again.

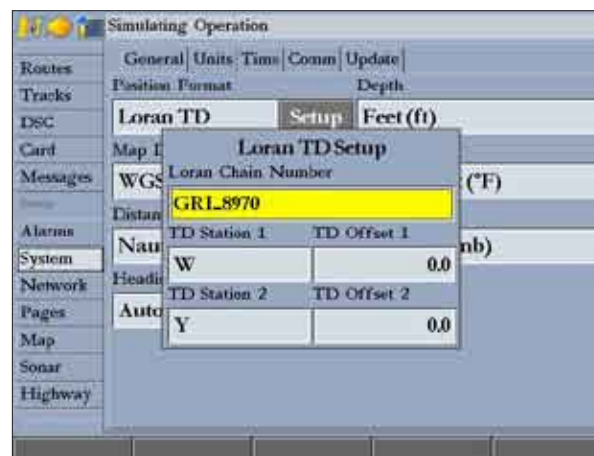

3. To change the settings of any of the five fields, highlight the field, press **ENTER**, select the setting you want, and press **ENTER** again.

If the active GRI Chain, secondary stations, or offsets were changed since the waypoint was created, the waypoint now references the active GRI-chain and secondary stations and adjusts the TD coordinates accordingly. Remember that the GPS is not relying on the LORAN signal for navigation and actually converts the TD coordinate to a useful latitude/longitude coordinate (in the background) before storing the waypoint to memory or using it for navigation. Because of this, the unit can navigate to a TD coordinate anywhere in the world.

For more information on LORAN TDs, you can download Garmin's *Loran TD Position Format Handbook* from the Garmin Web site.

## Caring for the GPSMAP 3006C/3010C

The GPSMAP 3006C/3010C case is constructed of high-quality materials and does not require user maintenance except cleaning.

### **Cleaning the Case**

Clean the unit's outer casing (except for the screen) using a cloth dampened with a mild detergent solution. Wipe dry. Avoid chemical cleaners and solvents that may damage plastic components.

### **Cleaning the Screen**

The GPSMAP 3006C/3010C lens is coated with a special anti-reflective coating that is sensitive to skin oils, waxes, and abrasive cleaners. Cleaners containing ammonia, alcohol, abrasives, or anti-grease detergents will harm the anti-reflective coating. It is important to clean the lens using an eyeglass lens cleaner that is specified as safe for anti-reflective coatings and a clean, lint-free cloth.

### **Storage**

Do not store the GPSMAP 3006C/3010C where prolonged exposure to extreme temperatures may occur (such as in the trunk of a car) because permanent damage may result. User information, such as waypoints and routes, are retained in the unit's memory without the need for external power. It is always a good practice to back up important user data by manually recording it, loading it to a computer (transferring it to MapSource), or storing it on a data card.

### **Water Immersion**

The GPSMAP 3006C/3010C is waterproof to IEC Standard 60529 IPX7. It can withstand immersion in 1 meter of water for 30 minutes. Prolonged submersion can cause damage to the unit. After submersion, be certain to wipe and air dry the unit before reuse.

## Navigation Terms

**Avg Speed**—the average of all second-by-second speed readings since the last reset.

**Bearing (BRG)**—the compass direction from your current location to a destination.

**Course**—the course between the active from and to waypoints.

**Depth**—the depth below the transducer. This field is active only if the GPSMAP 3006C/3010C is connected to a Garmin Sounder Module or if NMEA depth is available.

**Distance (Dist)**—the distance from the current location to a destination.

**Dist to Destination**—the distance from the current location to a Go To destination or the final waypoint in a route.

**Dist to Next**—the distance from current location to a Go To destination or the next waypoint in a route.

**DOP (Dilution of Precision)**—reflects the quality of the GPS signals and satellite geometry.

**Elevation**—the altitude (height) above mean sea level (MSL).

**ETA (Estimate Time of Arrival)**—the time you estimate to reach your destination waypoint, based on current speed and track.

**ETA at Destination**—the time you estimate to reach a Go To destination or the final waypoint in a route.

**ETA at Next**—the estimated time to reach a Go To destination or the next waypoint in a route.

**Fuel**—the fuel required to travel from your current location to the indicated route waypoint.

**GPS Accuracy**—estimated accuracy of the GPS position.

**Leg Dist**—the distance between two route waypoints.

**Leg Fuel**—the fuel required to travel from a route waypoint to the next waypoint in the route.

**Leg Time**—the time required to travel from a route waypoint to the next waypoint in the route.

**Max Speed**—the maximum second-by-second speed recorded since last reset.

**Moving Average Speed**—the average speed while the unit is moving.

**Moving Trip Timer**—the total time the unit has been moving.

**Odometer**—a running tally of the distance traveled, based on the distance between second-by-second position readings.

**Off Course**—the distance you are off course in any direction, left or right.

**Pointer**—the arrow indicating the direction to travel to the next point on the route.

**Speed**—the current velocity at which you are traveling, relative to ground position.

**Sunrise**—the time at which the sun rises on this day.

**Sunset**—the time at which the sun sets on this day.

**Time Of Day**—the current time.

**Time To**—the estimated time required to reach a Go To destination or the next waypoint in a route. Also known as “estimated time en route” (ETE).

**Time to Dest**—the estimated time required to reach a Go To destination or the final waypoint in a route.

**Time to Next**—the estimated time required to reach a Go To destination or the next waypoint in a route.

**To Course**—the recommended direction to steer to reduce course error or stay on course. Provides the most efficient heading to get back to the course and proceed along your route.

**Track**—the direction of movement relative to the ground. Also known as “ground track.”

**Trip Odometer**—a running tally of distance traveled since the last reset. See also “Odometer.”

**Total Average Speed**—the average speed of the unit for both moving and stopped speeds since the last timer reset.

**Total Trip Timer**—total time the unit has been in operation since the last reset of the trip timers.

**Turn**—the angle difference between the bearing to your destination and your current track. **L** indicates you should turn left; **R** indicates you should turn right.

**VMG (Velocity Made Good)**—the speed with which you are closing in on a destination along a course. Also referred to as the vector velocity to your destination.

**Voltage**—the current voltage reading being received by unit.

**Water Speed**—the speed through the water. This field is active only if the GPSMAP 3006C/3010C is receiving speed readings from a NMEA device or a Garmin Sounder Module.

**Water Temp**—the water temperature. This field is active only if the GPSMAP 3006C/3010C is receiving temp readings from a NMEA device or a Garmin Sounder Module.

**Waypoint Destination**—the final waypoint in the route or the destination waypoint.

**Waypoint Next**—the next waypoint in the route.

## Messages and Alarms

The GPSMAP 3006C/3010C uses an on-screen message system to notify you of events and alert you to problems. Press **QUIT** to acknowledge a message.

**Accuracy Alarm**—the GPS accuracy has fallen outside of the user-set value.

**Alarm Clock**—the alarm clock has sounded.

**Anchor Drag Alarm**—you have drifted out of the specified distance range.

**Approaching Turn**—you are nearing a turn in a route.

**Approaching <Waypoint>**—you are a specified distance from a destination waypoint.

**Arrival At <Waypoint>**—you have arrived at the destination waypoint.

**Battery Alarm**—battery voltage has fallen below the value specified in the Battery field on the Alarms tab.

**Battery Voltage Is Too High**—too much input voltage; the unit will shut off in 10 seconds. Decrease the input voltage to less than 32 volts.

**Boat is not Moving Fast Enough to Calibrate**—the boat is not moving fast enough for the speed wheel to provide a valid speed.

**Can't Read User Card**—error reading card; remove and reinsert. Contact your dealer or Garmin Product Support if the problem persists.

**Can't Read Voltages That High, Limited To Top Of Range**—voltage range must be between 10.0 and 35.0 volts for the GPSMAP 3006C/3010C.

**Can't Read Voltages That Low, Limited To Bottom Of Range**—voltage range must be between 10.0 and 35.0 volts for the GPSMAP 3006C/3010C.

**Can't Send Waypoint**—the unit cannot transmit the waypoint using the NMEA WPL sentence. Check the wiring.

**Can't Unlock Maps**—the data on the data card is not unlocked for the unit. Contact your dealer or Garmin Product Support.

**Can't Write User Card**—error writing to the card; remove and reinsert. Contact your dealer or Garmin Product Support if the problem persists.

**Database Error**—internal problem with the unit. Contact your dealer or Garmin Product Support to have the unit serviced.

**Deep Water Alarm**—the depth has changed by the amount of the Drift Alarm value.

**Directory Item With This MMSI Already Exists**—the MMSI number is already in the DSC directory. Use a different number.

**Directory Memory is Full Can't Create Entry**—the DSC directory has reached the maximum of 100 contacts. Delete unneeded contacts to add new ones.

**Distress Call**—a DSC distress call has been received. Take appropriate action.

**Drift Alarm**—the depth has changed by the amount of the Drift Alarm value.

**Fish Alarm**—shows an icon and beeps (if enabled) when a fish is detected. This alarm does not show a message banner.

**Invalid MMSI**—enter a valid MMSI.

**Lost Remote GPS Connection**—there is a problem with the GPS antenna wiring. Check the connections.

**Lost Satellite Reception**—the unit has lost satellite signals. Check the antenna connections or try moving to a location with a clear view of the sky.

**NMEA Depth Is Below Transducer**—you must enter an appropriate Keel Offset for the transducer.

**No Proximity Waypoints/Routes/Tracks/User Waypoints Found**—you attempted to transfer user data from a data card that does not contain the specified type of data. Make sure there is data to transfer on data card.

**None Found**—no data matched the search criteria.

**Not All Maps Fit, Some Maps will not be drawn**—the maximum number of individual maps on the data card was exceeded.

**Off Course Alarm**—you exceeded the specified off-course distance.

**Proximity Alarm Memory is Full**—you used all available proximity waypoints.

**Proximity Alarm: <Waypoint>**—you entered the alarm radius for the proximity waypoint indicated.

**Proximity Overlaps Another Proximity Waypoint**—the alarm radius specified overlaps the area specified for another proximity waypoint. Adjust the distance.

**Route Already Exists: <route name>**—you entered a route name that already exists in memory. Modify the route name or delete the previous route name.

**Route Is Full**—you attempted to add more than 300 points to a route. Reduce the number of points or create a second route.

**Route Memory Is Full, Can't Create Route**—the maximum amount of 300 routes is already in the unit's memory, and no additional routes can be added until existing ones are removed.

**Route Truncated**—an uploaded route from another device has more than 300 points and was truncated to fit.

**Route Waypoint Memory Full**—no additional route waypoints can be saved.

**Shallow Water Alarm**—the Shallow Water Alarm depth has been reached.

**Simulating Operation**—the unit is in Simulator Mode. Do not use this mode for normal navigation!

**Sonar Failed, Unit Needs Repair**—there is an internal problem with the unit. Contact your dealer or Garmin Product Support to have the unit serviced.

**Sonar Service Incompatible**—the external sonar device you are connected to needs a software update.

**Sonar Service Lost**—the external sonar device you were connected to has either been disconnected, or the GPSMAP 3006C/3010C has lost communication with the sonar device for some other reason.

**Timer Alarm**—the Timer has reached to 00:00:00.

**Track Already Exists: <track name>**—you entered a saved track name that already exists in memory. Modify the track name or delete the existing track.

**Track Memory Is Full, Can't Create Track**—the track log memory is full. No additional track log data can be stored without deleting old data.

**Track Truncated**—a complete uploaded track does not fit into memory. The oldest track log points were deleted to make space for the most recent data.

**Transducer Disconnected, Sonar Turned Off**—no transducer is attached, the cable/transducer is bad, or the transducer cable was disconnected. If the transducer cable is removed while the unit is on, reconnect and cycle power.

**Transfer Complete**—the unit has finished uploading or downloading information to the connected device.

**User Card Not Found**—you attempted to transfer user data without a data card in the data card slot.

**Water Speed Sensor is not Working**—the speed sensor is not detected. Check the connections.

**Water Temperature Alarm**—sonar has reported a temperature above, below, inside, or outside the specified values.

**Waypoint Already Exists: <Waypoint>**—you entered a waypoint name that already exists in memory. Modify the waypoint name or delete the existing waypoint.

**Waypoint Memory Is Full, Can't Create Waypoint**—you have used all 4,000 waypoints available. Delete unwanted waypoints to make space for new entries.

## Optional Accessories

The following accessories are designed to enhance the operation of your GPSMAP 3006C/3010C chartplotter.

To obtain replacement parts and optional accessories, contact your Garmin Dealer, Garmin Product Support in the U.S.A. at 800-800-1020, or Garmin Europe at 44-0870-8501241.



**WARNING:** Garmin accessories have been designed and specifically tested for use with Garmin products. Accessories offered by other manufacturers have not been tested or approved for use with Garmin products. Use of such accessories could cause damage to the GPSMAP 3006C/3010C and void the warranty.

**Bluechart g2 Preprogrammed Data Cards**—enhance the basemap; featuring additional data including highly detailed coastal roads and points of interest such as restaurants, lodging, local attractions and more. Full-color aerial photos of ports, marinas, bridges, and navigational landmarks are also included on many data cards.

**GDL 30/GDL 30A Marine Weather XM Satellite Receiver**—provides graphical and textual marine XM WX weather information that can be viewed through the GPSMAP 3006C/3010C when you subscribe to the XM WX Satellite Weather service.

**GMS 10 Network Port Expander**—enables you to connect more than two chartplotters and other Garmin Marine Network devices to share data such as weather, mapping, sounder data, and position information.

**GSD 20, GSD 21, and GSD 22 Remote Sounder Module and Transducers**—provides sonar capabilities to the GPSMAP 3006C/3010C.

**GMR 20/40, GMR 21/41, and GMR 404/406 Marine Radar**—adds important radar information to the GPSMAP 3006C/3010C.

**Marine Network Cables (RJ45)**—connect your Garmin Marine Network devices.

**MapSource Software CD-ROMs**—enhances the basemap and creates waypoints and routes from your computer. MapSource offers several detailed mapping options that are compatible with the GPSMAP 3006C/3010C, including BlueChart.

**Marine Data Management Kit**—allows you to archive data, plan routes, and stay on top of software updates for your chartplotter using your PC. The software includes a marine updater application, which links you to the Garmin Web site for free software updates for your chartplotter. This application works with the Garmin Marine Network, enabling you to update every component of your system.

**Programmable Data Cards**—blank data cards are available in 16 MB, 32 MB, 64 MB, and 128 MB sizes. Download street-level map detail, points of interest, business addresses and phone numbers, marine data, topographical information, and more from MapSource CD-ROMs to a data card, either directly through your GPSMAP 3006C/3010C using the PC Interface Cable, or with the Data Card Programmer.

**USB Data Card Programmer**—programs blank data cards and downloads maps to a data card at high speed using the USB port on your PC.

**Preprogrammed Data Cards**—data cards that are preprogrammed with either Garmin BlueChart or Fishing Hot Spots map data.



## Limited Warranty

This Garmin product is warranted to be free from defects in materials or workmanship for one year from the date of purchase. Within this period, Garmin will, at its sole option, repair or replace any components that fail in normal use. Such repairs or replacement will be made at no charge to the customer for parts or labor, provided that the customer shall be responsible for any transportation cost. This warranty does not cover failures due to abuse, misuse, accident, or unauthorized alteration or repairs.

This product is intended to be used only as a travel aid and must not be used for any purpose requiring precise measurement of direction, distance, location, or topography. Garmin makes no warranty as to the accuracy or completeness of map data in this product.

THE WARRANTIES AND REMEDIES CONTAINED HEREIN ARE EXCLUSIVE AND IN LIEU OF ALL OTHER WARRANTIES EXPRESS, IMPLIED, OR STATUTORY, INCLUDING ANY LIABILITY ARISING UNDER ANY WARRANTY OF MERCHANTABILITY OR FITNESS FOR A PARTICULAR PURPOSE, STATUTORY OR OTHERWISE. THIS WARRANTY GIVES YOU SPECIFIC LEGAL RIGHTS, WHICH MAY VARY FROM STATE TO STATE.

IN NO EVENT SHALL GARMIN BE LIABLE FOR ANY INCIDENTAL, SPECIAL, INDIRECT, OR CONSEQUENTIAL DAMAGES, WHETHER RESULTING FROM THE USE, MISUSE, OR INABILITY TO USE THIS PRODUCT OR FROM DEFECTS IN THE PRODUCT. SOME STATES DO NOT ALLOW THE EXCLUSION OF INCIDENTAL OR CONSEQUENTIAL DAMAGES, SO THE ABOVE LIMITATIONS MAY NOT APPLY TO YOU.

Garmin retains the exclusive right to repair or replace the unit or software or offer a full refund of the purchase price at its sole discretion. SUCH REMEDY SHALL BE YOUR SOLE AND EXCLUSIVE REMEDY FOR ANY BREACH OF WARRANTY.

To obtain warranty service, contact your local Garmin authorized dealer or call Garmin Product Support for shipping instructions and an RMA tracking number. Securely pack the unit and a copy of the original sales receipt, which is required as the proof of purchase for warranty repairs. Write the tracking number clearly on the outside of the package. Send the unit, freight charges prepaid, to any Garmin warranty service station.

**Online Auction Purchases:** Products sold through online auctions are not eligible for rebates or other special offers from Garmin. Online auction confirmations are not accepted for warranty verification. To obtain warranty service, an original or copy of the sales receipt from the original retailer is required. Garmin will not replace missing components from any package purchased through an online auction.

**International Purchases:** A separate warranty is provided by international distributors for units purchased outside the United States. This warranty is provided by the local in-country distributor and this distributor provides local service for your unit. Distributor warranties are only valid in the area of intended distribution. Units purchased in the United States or Canada must be returned to the Garmin service center in the United Kingdom, the United States, Canada, or Taiwan for service.

Garmin International, Inc.  
1200 East 151st Street,  
Olathe, Kansas 66062, USA  
Tel. (913) 397-8200 or  
(800) 800-1020  
Fax (913) 397-8282

Garmin (Europe) Ltd.  
Liberty House  
Hounslow Business Park,  
Southampton, Hampshire, SO40 9RB, UK  
Tel. +44 (0) 870.8501241 (outside the UK)  
0808.2380000 (within the UK)  
Fax +44 (0) 870.8501251

Garmin Corporation  
No. 68, Jangshu 2nd Road,  
Shijr, Taipei County, Taiwan  
Tel. 886/2.2642.9199  
Fax 886/2.2642.9099

## FCC Compliance

This device complies with part 15 of the FCC Rules. Operation is subject to the following two conditions: (1) this device may not cause harmful interference, and (2) this device must accept any interference received, including interference that may cause undesired operation.

This equipment has been tested and found to comply with the limits for a Class B digital device, pursuant to part 15 of the FCC rules. These limits are designed to provide reasonable protection against harmful interference in a residential installation. This equipment generates, uses, and can radiate radio frequency energy and may cause harmful interference to radio communications if not installed and used in accordance with the instructions. However, there is no guarantee that interference will not occur in a particular installation. If this equipment does cause harmful interference to radio or television reception, which can be determined by turning the equipment off and on, the user is encouraged to try to correct the interference by one of the following measures:

- Reorient or relocate the receiving antenna.
- Increase the separation between the equipment and the receiver.
- Connect the equipment into an outlet that is on a different circuit from the GPS unit.
- Consult the dealer or an experienced radio/TV technician for help.

This product does not contain any user-serviceable parts. Repairs should only be made by an authorized Garmin service center. Unauthorized repairs or modifications could result in permanent damage to the equipment, and void your warranty and your authority to operate this device under Part 15 regulations.

## Industry Canada Compliance

Category I radiocommunication devices comply with Industry Canada Standard RSS-210.

Category II radiocommunication devices comply with Industry Canada Standard RSS-310.

## Declaration of Conformity (DoC)

Hereby, Garmin declares that this GPSMAP 3006C/3010C is in compliance with the essential requirements and other relevant provisions of Directive 1999/5/EC.

To view the full Declaration of Conformity, see the Garmin Web site for your Garmin product: [www.garmin.com/products/gpsmap3006c/](http://www.garmin.com/products/gpsmap3006c/). Click **Manuals** and then select the **Declaration of Conformity**.

## XM Satellite Radio Service Agreement

### *XM Satellite Radio Inc.*

Hardware and required monthly subscription sold separately. Subscription fee is consumer only. Other fees and taxes, including a one-time activation fee may apply. All programming fees and weather data subject to change. XM WX weather data displays and individual product availability vary by hardware equipment. Reception of the XM signal may vary depending on location. Subscriptions subject to Customer Agreement included with the XM Welcome Kit and available at [xmradio.com](http://xmradio.com). Available only in the 48 contiguous United States. XM WX is a trademark of XM Satellite Radio Inc.

## Weather Data Warranty

THE WEATHER DATA SOFTWARE PRODUCT IS PROVIDED “AS IS.” ALL OTHER WARRANTIES, EXPRESSED OR IMPLIED, INCLUDING ANY WARRANTY OF MERCHANTABILITY OR FITNESS FOR A PARTICULAR PURPOSE OR OF NON-INFRINGEMENT ARE HEREBY EXCLUDED.

### USER SAFETY

If you use XM Services it is your responsibility to exercise prudent discretion and observe all safety measures required by law and your own common sense. You assume the entire risk related to your use of the Services. XM and Garmin assume no responsibility for accidents resulting from or associated with use of the Services. Your Radio Service includes traffic and weather information, and you acknowledge that such information is not for “safety for life”, but is merely supplemental and advisory in nature, and therefore cannot be relied upon as safety-critical in connection with any aircraft, sea craft or automobile usage. This information is provided “as is” and XM and Garmin disclaim any and all warranties, express and implied, with respect thereto or the transmission or reception thereof. XM and Garmin further do not warrant the accuracy, reliability, completeness or timeliness of the traffic and weather information disclosed on the Radio Service. In no event will XM and Garmin, their data suppliers, service providers, marketing/distribution, software or Internet partners or hardware manufacturers be liable to you or to any third party for any direct, indirect, incidental, consequential, special, exemplary or punitive damages or lost profits resulting from use of or interruptions in the transmission or reception of the Services.

### LIMITS ON OUR RESPONSIBILITY

#### a) DISCLAIMERS.

EXCEPT AS EXPRESSLY PROVIDED HEREIN, WE MAKE NO WARRANTY OR REPRESENTATION, EITHER EXPRESS OR IMPLIED, REGARDING THE RADIO SERVICE. YOUR USE OF THE SERVICE IS AT YOUR SOLE RISK. THE CONTENT AND FUNCTIONALITY OF THE SERVICE IS PROVIDED “AS IS” WITHOUT ANY WARRANTY OF ANY KIND, EXPRESS OR IMPLIED. ALL SUCH WARRANTIES OR REPRESENTATIONS (INCLUDING, WITHOUT LIMITATION, THE IMPLIED WARRANTIES OF MERCHANTABILITY, FITNESS FOR A PARTICULAR PURPOSE, TITLE AND NON-INFRINGEMENT) ARE HEREBY DISCLAIMED.

#### b) LIMITATIONS OF LIABILITY.

WE ARE NOT RESPONSIBLE FOR ANY SPECIAL, INCIDENTAL, OR CONSEQUENTIAL DAMAGES OR LOSSES RELATING TO THE USE OF THE RADIO SERVICE, WHETHER BASED ON NEGLIGENCE OR OTHERWISE. OUR TOTAL LIABILITY TO YOU AND ANY OTHER PERSONS RECEIVING OUR SERVICES, REGARDLESS OF THE CAUSE, WILL IN NO EVENT EXCEED THE AMOUNTS THAT YOU HAVE PAID TO US FOR THE SERVICE THAT YOU RECEIVED DURING THE SIX (6) MONTH PERIOD IMMEDIATELY PRIOR TO THE SPECIFIC EVENT THAT GAVE RISE TO THE APPLICABLE DAMAGE OR LOSS. THIS ALLOCATION OF RISK IS REFLECTED IN OUR PRICES. YOU MAY HAVE GREATER RIGHTS THAN DESCRIBED ABOVE UNDER YOUR STATE’S LAWS

This product was developed using DAFIF™, a product of the National Geospatial-Intelligence Agency.

This product has not been endorsed or otherwise approved by the National Geospatial-Intelligence Agency, or the United States Department of Defense (10 U.S.C. 425)

a. Under 10 U.S.C. 456, no civil action may be brought against the United States on the basis of the content of a navigational aid prepared or disseminated by either the former Defense Mapping Agency (DMA), National Imagery and Mapping Agency (NIMA), or the National Geospatial-Intelligence Agency (NGA).

b. The DAFIF™ product is provided “as is,” and no warranty, express or implied, including, but not limited to the implied warranties of merchantability and fitness for particular purpose or arising by statute or otherwise in law or from a course of dealing or usage in trade, is made by NGA as to the accuracy and functioning of the product.

c. Neither NGA nor its personnel will be liable for any claims, losses, or damages arising from or connected with the use of this product. The user agrees to hold harmless the United States National Geospatial-Intelligence Agency. The user’s sole and exclusive remedy is to stop using the DAFIF product.

## European License Requirements

The following table shows European License requirements for the GMR 20/40, GMR 21/41, and GMR 404/406 marine radar.

Austria	I	Luxembourg	I
Belgium	G	The Netherlands	I
Czech Republic	I	Poland	G
Denmark	G	Portugal	G
Estonia	I	Slovakia	*
Finland	I	Slovenia	G
France	G	Spain	*
Germany	G	Sweden	G
Greece	G	United Kingdom	I
Hungary	*	Cyprus	G
Ireland	I	Malta	*
Italy	G	Iceland	G
Latvia	I	Norway	I
Lithuania	G	Switzerland	I

**I**—requires an individual license for operation.

**G**—can be operated under a general license or license exemption.

\* This product may require licensing in your country of use. Refer to the national radio or telecommunications office or ministry.

# INDEX

## Symbols

- 200 kHz frequency 76
- 2X zoom 81
- 3D Highway Page 42
- 4X zoom 81
- 50 kHz frequency 76

## A

- A-scope 81
- accessories 112
- accuracy 7
- accuracy circle 70
- acquiring satellites 6
- active track log 53
- ADJ/MENU Key 2
- advanced map card setup 72
- Advanced sub tab 100
- AFC mode 100
- AIS 71
- alarms
  - navigation 59
  - proximity 52
  - sonar 60
  - system 59
  - weather 60
- Alarms tab 58
- anchor drag 59
- arches 77
- arrival alarm 59
- atmosphere 86
- auto-detect services 97
- AutoLocate 7
- automatic backlight 61
- Automatic Identification System. *See* AIS

- auto color gain 83
- auto gain 83

## B

- backlight 5, 61
  - adjusting 5
- basic operation 9
- battery alarm 59
- Bearing Line 99
- Bearing pointer 41
- bearing reference 98, 99
- beeper 61
- begin transmitting 96
- BlueChart 12
- BlueChart g2 38, 112
- bottom of the water 77
- btm (bottom) lock 81

## C

- calibrate water speed 83
- Card tab 57
- cartography 38
- Celestial tab 49
- center offset 98
- chart 69
- cleaning 107
- clock alarm 59
- clutter 77
  - rain 92
  - sea 92
- color 77
- color bar 81
- color gain 80
- Comm tab 64
- Compass Page 41
- configuring
  - Radar Page 91

- Course Up 69
- create
  - routes 26
  - waypoints 14
- creating waypoints
  - manually 15
  - using the map 14
- cross-talk rejection 98
- currents 48

## D

- DATA/CNFG key 2
- data cards
  - installing 102
  - removing 102
  - transferring data to/from 57
- data card slots 1
- data entry keys 4
  - using 10
- data fields 33
- data transfer 64
- date/time 103
- datums 63
- daylight saving 64
- Declaration of Conformity (DoC) 114
- deep water alarm 60
- default settings 9
- delete
  - routes 28
  - tracks 54
  - waypoints 19
- delete by symbol 19
- depth 62
- depth line 81
- digital data fields 33
- digital navigation data 90
- digital selective calling. *See* DSC

- Dilution of Precision 108
- Display sub tab 98
- distance units 63
- distress calls 104
- DOP 108
- DSC 54, 104
  - directory 56
  - distress call 55, 105
  - log 55
  - position report 55, 105
  - setup 56
- DSC Item Review 55
- DSC tab 54
- dual beam 76
- dual frequency 76

## E

- EBL 94. *See* Electronic Bearing Line
- edit
  - routes 28
  - waypoints 16
- EGNOS 103
- elevation units 63
- ENTER/MARK Key 2, 14
- entering data 10
- enter standby 96
- European License Requirements 116

## F

- factory defaults 34, 61
- FCC compliance 114
- FCTN key 35
- features 9
- FIND key 2
- fish symbols 78, 84
- flasher 79
- Follow Track 22

frequency 81  
     200 kHz 76  
     50 kHz 76  
 FTC 92  
 function adjustments 35  
 function windows 35

**G**  
 gain 80, 92  
 gain setting 77  
 Garmin Marine Network 95  
 GDL 30 60, 86, 112  
 GMR 20/40 i  
 GMR 21/41 i  
 GMR 404/406 i, 96  
 Go To Point 21  
 GPS accuracy alarm 59  
 GPS receiver  
     initializing 6  
 GPS status icon 6  
 GPS tab 6, 45  
 GSD 20 i, 60, 76  
 GSD 21 i, 60, 76  
 GSD 22 i, 60, 76  
 guard zone 92, 94  
     defining 94

**H**  
 hardness of the bottom 77  
 hard structure 77  
 heading 63  
 heading line 90, 98  
 heading sensor 95  
 hide/show navigation features 92  
 highlight 9  
 Highway Page  
     options 43

Highway Page, 3D 42

**I**  
 installation i  
 invert route 27

**L**  
 labels 70  
 language 61  
 leg distance 31  
 leg time 31  
 log, temperature 85  
 log and graph scale 85  
 log duration 73  
 LORAN TD 106–107  
     setting up 106  
     using 106

**M**  
 magnetic north 63  
 Main Menu 45–75  
     Card tab 57  
     Celestial tab 49  
     GPS tab 45  
     Highway tab 74  
     Messages tab 58  
     Network tab 66  
     overview 45  
     Pages tab 67  
     Points tab 51  
     Radar tab 72  
     Routes tab 52  
     Sonar tab 73  
     System tab 60  
     Temp tab 73  
     Tide tab 46  
     Tracks tab 53

    Trip tab 50  
     Weather tab 88–89  
     XM tab 74–75

main pages  
     3D Highway Page 42  
     Compass Page 41  
     configuring 33  
     Map Page 36–39  
     Map Split Page 41  
     Radar Page 91–95  
     Video Page 44

manage user card 57  
 manually adjust the radar 100  
 MapSource 57, 102  
 map data 11  
 map datums 63  
 map outlines 68  
 Map Page 36–39  
     distance and bearing 39  
     options 39  
     ranges 37  
 map pointer 11  
     moving 11  
 map ranges 37  
 Map Split Page 41  
 Map tab 68–72  
     AIS sub tab 71  
     detail sub tab 69  
     nav sub tab 70  
     prefs sub tab 68  
     source sub tab 71

marine remote control 3  
 Maritime Mobile Service Identity. *See* MMSI  
 MARPA 92, 95–96  
     list 96  
     target 95

MARPA sub tab 97, 99  
 merge from card 57  
 messages 110  
 Messages tab 58  
 MMSI number 105  
 MOB 25  
 moon phase 49  
 moon rise/set 49  
 motor speed  
     high 96  
     normal 96

**N**  
 narrow beam 76  
 NAV/MOB Key 2, 21, 24, 56  
 navigating a saved route 26  
 Navigation Features 92, 98, 99  
 navigation terms 110  
 Nav alarms 59  
 Network tab 66  
 NMEA 64  
 NMEA interface 65  
 NMEA output setup 65  
 north reference 63

**O**  
 off course alarm 59  
 on-screen buttons 10  
 options  
     selecting 10  
 orientation 69, 98  
 Own Vessel Safe Zone 99

**P**  
 Pages tab 67  
 PAGE key 2  
 pointer mode 37

- position format 62
- position mode 37
- position report 55, 104
- POWER key 2
- precipitation 86
- pressure 63
- proximity alarms 20
- proximity waypoints 20
  - clearing 20
- proximity waypoint list 20

## Q

- QUICK NAV route 27
- QUIT key 2

## R

- Radar 89–100
  - adjustment menu 92
  - background color 98
  - range rings 89
  - understanding 89
- radar overlay 97
- Radar Page 91
  - configuring 91
  - viewing 91
- Radar tab 72, 97–100
  - Advanced sub tab 100
  - Display sub tab 98
  - General sub tab 98
  - MARPA sub tab 99
- radar warming up 89
- rain clutter 92
- RANGE keys 2
- range rings 90
- re-evaluate route 27
- receiver status 7
- replace from card 57

- review waypoint page 16
- rings 98
- ROCKER key 2
- routes 25–31
  - copying 27
  - creating 25
  - deleting 28
  - editing 28
  - navigating 36
  - planning 31
  - quick nav 27
- Routes tab 52

## S

- safety feature 89
- safe zone ring 99
- satellite location 103
- satellite sky view 103
- saturation, video 44
- saved tracks 54
- scale, log and graph 85
- scroll bar 9
- sea clutter 92
- sea surface 86
- serial number
  - electronic 61
- services 61
- Setup tab 61
- set position 7
- shallow water alarm 60
- shortcut keys 4
- signal strength 100
- simulator 61
- simulator mode 8
  - setting up 8
  - turning off 8
  - turning on 8

- simulator set position 8
- simulator track 8
- simulator track control 8
- skyview orientation 7
- software license agreement v
- software update 91
- software version 61
- soft keys 4, 10, 90
- soft structure 77
- Sonar
  - understanding 76–85
- sonar alarms 60
- Sonar Page 78–81
  - adjustment menu 80
  - configuring 79
- Sonar tab 82–85
- sound waves 76
- source, GPS 7
- source, video 44
- specifications 101
- speed filter 61
- speed units 63
- spinning up 90
- standard, video 44
- status bar 4, 6, 89
- storage 107
- strongest sonar returns 77
- sun rise/set 49
- surface clutter 77
- symbol set 68
- system alarms 59
- system information 61
- system mode 61
- System tab 61
  - comm sub tab 64
  - general sub tab 61
  - time sub tab 63

- units sub tab 62

## T

- target expansion 92, 93
- target history 99
- temperature 63, 73
- temperature graph 81
- temperature log 85
- temperature scale 73
- Temp tab 73
- tides 46
- Tide Stations 47
- Tide tab 46
- Timed Transmit 98
- Timed Transmit STBY Time 98
- Timed Transmit XMIT Time 98
- time duration 85
- time format 64
- Time To Safe Zone 99
- time zone 64
- TracBack 22, 24
  - Tips 24
- Tracks
  - deleting 54
  - reviewing 23
  - saving 23
- Tracks tab 53
- track color 53
- track logs 23, 53
- track up 69
- track value 53
- trails 92, 93
- Trip tab 50
- turn unit on and off 5

## U

- Ultrasroll 81

underwater waypoints 82  
user waypoint list 19

## V

vector length 99  
velocity reference 99  
video

    aspect 44  
    contrast 44

Video Page 44

VRM 94

VRM/EBL 92  
    adjusting 95

## W

WAAS 7, 103, 104

warming up 89

Warning Page 6

water immersion 107

water speed 83, 109

water temperature alarm 60

waypoints 14–26, 99

    creating 14  
    deleting 19  
    editing 16  
    marking 14, 82  
    moving 18  
    proximity 20  
    reviewing 16  
    underwater 82  
    using 14

waypoint list 18

waypoint name  
    changing 17

waypoint symbol  
    changing 17

weakest returns 77

Weather tab 88–89

whiteline 78, 80

Wide Area Augmentation System. *See* WAAS

wide beam 76

## X

XM tab 74–75

XM WX weather 86–88

    customizing 86

    forecast 88

## Z

zoom 37, 43, 81, 92, 93

Zoom level 93





**For the latest free software updates (excluding map data) throughout the life of your  
Garmin products, visit the Garmin Web site at [www.garmin.com](http://www.garmin.com).**



© 2007 Garmin Ltd. or its subsidiaries

Garmin International, Inc.  
1200 East 151<sup>st</sup> Street, Olathe, Kansas 66062, USA

Garmin (Europe) Ltd.  
Liberty House, Hounsdown Business Park, Southampton, Hampshire, SO40 9RB UK

Garmin Corporation  
No. 68, Jangshu 2<sup>nd</sup> Road, Shijr, Taipei County, Taiwan

[www.garmin.com](http://www.garmin.com)

Part Number 190-00371-00 Rev. G